

# **GRAFTON HIGH SCHOOL**

## **ACADEMIC & CAREER PLANNING COURSE GUIDE**



**2024-2025**



**Grafton High School**  
1950 Washington Street  
Grafton, Wisconsin 53024  
(262) 376-5500



#### Administration

Mr. Scott Mantei	Principal
Mr. Kevin Moore	Associate Principal/Athletic Director
Mr. Mike Kalina	Associate Principal

#### School Counselors

Mr. Greg Johnson	School Counselor, Director (A-G)
Ms. Emily May	School Counselor (H-Q)
Ms. Jenny Marks	School Counselor (R-Z)
Ms. Kelly Rieck	Registrar

#### NONDISCRIMINATION AND ACCESS TO EQUAL EDUCATIONAL OPPORTUNITY

All courses, including Career and Technical Education courses, are available without discrimination based on race, color, religion, national origin, ancestry, creed, pregnancy, marital status, parental status, sexual orientation, sex, (including gender status, change of sex or gender identity), or physical, mental, emotional, or learning disability, or any other characteristic protected by law (Protected Classes).

# Table of Contents

Note: The items below are live-linked. Therefore, you can click on the heading and jump to that page. Control + Home will go back to the beginning of the book.

<b>INTRODUCTION</b>	<b>3</b>
<b>ACADEMIC PREPARATION INFORMATION</b>	<b>6</b>
<b>REFLECTIVE QUESTIONS FOR STUDENTS</b>	<b>7</b>
<b>THE 16 CAREER CLUSTERS</b>	<b>9</b>
<b>COURSE PLANNING SHEET</b>	<b>11</b>
<b>GRAFTON HIGH SCHOOL</b>	<b>14</b>
<b>ACADEMIC OPPORTUNITIES</b>	<b>14</b>
<b>ADDITIONAL PLANNING INFORMATION</b>	<b>16</b>
<b>ART</b>	<b>18</b>
<b>BUSINESS &amp; INFORMATION TECHNOLOGY</b>	<b>21</b>
<b>COMMUNICATION ARTS</b>	<b>25</b>
<b>COMPUTER SCIENCE</b>	<b>29</b>
<b>FAMILY AND CONSUMER SCIENCE</b>	<b>30</b>
<b>MATHEMATICS</b>	<b>33</b>
<b>MUSIC</b>	<b>35</b>
<b>PHYSICAL EDUCATION AND HEALTH</b>	<b>38</b>
<b>SCIENCE</b>	<b>41</b>
<b>SOCIAL STUDIES</b>	<b>45</b>
<b>TECHNOLOGY AND ENGINEERING</b>	<b>49</b>
<b>WORLD LANGUAGE</b>	<b>54</b>

## **INTRODUCTION**

We believe that all students can learn at high levels, and the district's comprehensive curriculum, aligned to state standards, reflects this core belief. Our dedicated, highly qualified staff work collaboratively to design and implement instructional programming to meet the needs of our diverse learners. The mission of the Grafton School District is to prepare learners for a dynamic tomorrow. Our vision is to build a collaborative, versatile environment that fosters creative, adaptable, lifelong learners prepared to succeed in an ever-changing global community. The *Grafton High School Academic and Career Planning Guide* reflects the district's vision by offering a comprehensive range of classes designed to provide students and families the information needed to plan for student success in high school and to be college, career and life ready. ([Vision 2030](#))

### **Course Selection Information**

Once a student requests a course, a series of commitments on the part of the school is made. Courses offered will depend on enrollment requests. A minimum number of students must request a course before the course will

[Table of Contents](#)

be offered. When a course is canceled, the student may select another course in its place. Course selection, therefore, is extremely important and should be considered as much a commitment on the part of the student as the school. The array of courses offered at Grafton High School are designed to prepare students with differing interests and abilities for a variety of post high school options.

**Some English, Social Studies, Mathematics, or Science courses which meet graduation requirements do not meet academic credit requirements for admission to the University of Wisconsin system and other colleges and universities.**

The University of Wisconsin System admission requires 17 “college-preparatory units” including four years of English, three years of Social Studies, three years of Mathematics (algebra and higher), three years of Science, and four years of additional college preparatory electives. All colleges and universities highly **recommend** four years of core classes: English, Math, Science, and Social Studies. Two years of a World Language may be required at some colleges, but three to four years of a single world language is highly recommended by UW-Madison. All universities view world language as strong college preparation.

There is a general agreement between the universities and high schools regarding acceptable college preparatory credits. However, this may vary between one institution of higher education and another.

It is the responsibility of the student to confirm this information with the university/college admissions office.

### **2023-2024 Course Revisions**

Course offerings at Grafton High School are annually reviewed for consideration of new courses to increase learning opportunities for our students. In addition, courses are also reviewed through the curriculum cycle. Below are changes for the 2024-2025 school year:

#### **Family & Consumer Science**

- New Prerequisite for Advanced Foods & Restaurant Management
  - Baking Principles & Food Concepts with a “C” or better

#### **Math**

- New Course
  - AP Precalculus (1 credit)
- Name Change
  - FST has changed to Intro to College Algebra & Trigonometry

#### **Music**

- New Course
  - Music Appreciation (.5 credit)

#### **Technology & Engineering**

- *Advanced Autos*
  - In alignment with ASE recertification and Fox Valley Technical College Partnership
    - Students will be required to attend BHT on Thursdays and Fridays

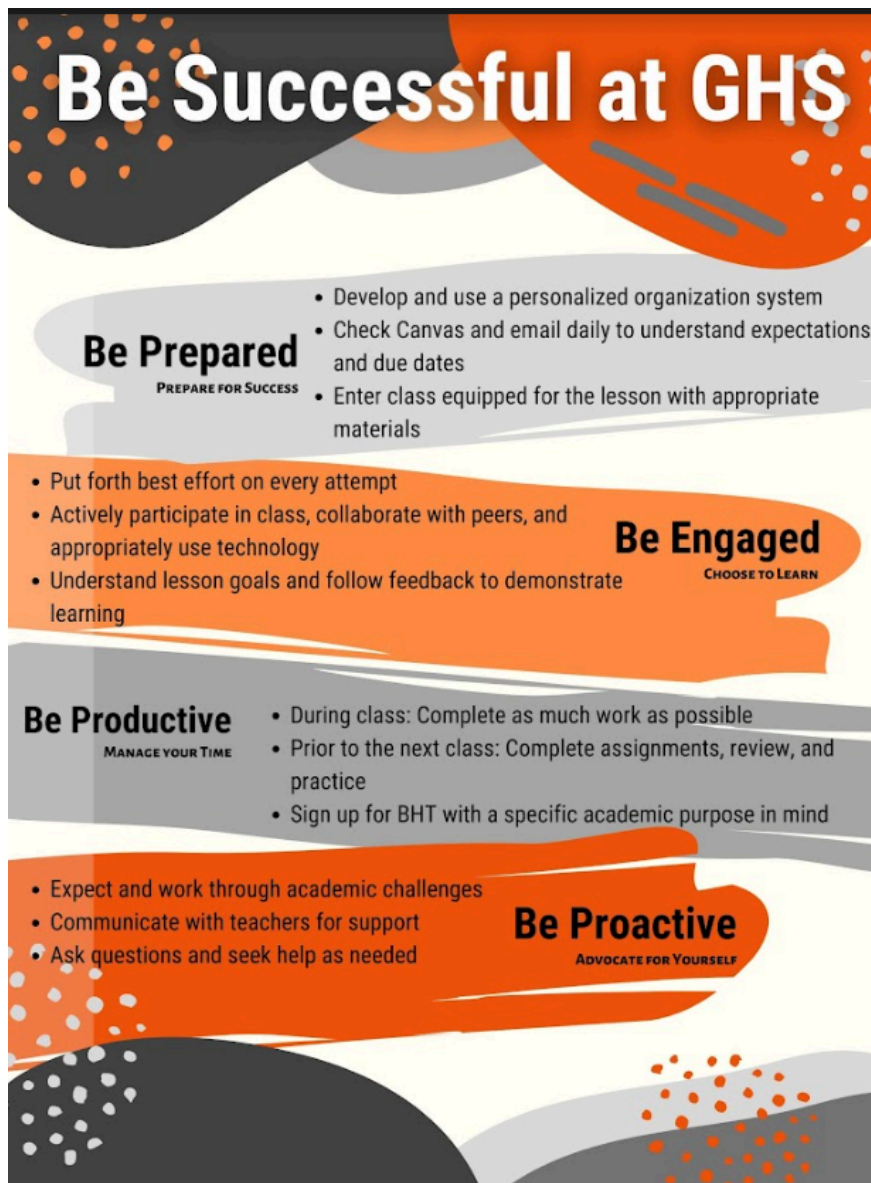

## GRAFTON HIGH SCHOOL GRADUATION REQUIREMENTS

### 24 Credits Required

- 4 credits English
- 3 credits Social Studies
  - Global Studies or AP Human Geography (1 credit)
  - United States History or AP US History (1 credit)
  - American Government (.5 credit)
- 3 credits Mathematics
- 3 credits Science
  - Biology (1 credit)
- 1.5 credits Physical Education
- 0.5 credits Health
- 0.5 credit Financial Literacy
- 8.5 additional credits

### Financial Literacy Requirement

All students are required to meet the financial literacy requirement. Students must select one of the following .5 credit courses:

- |                            |                     |                      |
|----------------------------|---------------------|----------------------|
| • Personal Finance         | • AP Macroeconomics | • Independent Living |
| • College Personal Finance | • AP Microeconomics |                      |

**Civics Exam Requirement** - Per Wis. Stat. s. 118.33(1m)(a)1. All students are required to pass the WI Civics Exam. Visit the Department of Public Instruction [website](#) for more information

# GRAFTON HIGH SCHOOL

## ACADEMIC PREPARATION INFORMATION

Subject	Grafton HS	Minimum College Prep	University of WI System	Selective Universities
English	4 credits	4 credits	4 credits	4 + credits including honors and/or AP
Mathematics	3 credits	3 credits (at least Algebra, Geometry, Algebra 2)	3 credits (at least Algebra, Geometry, Algebra 2)	4 credits (including honors and/or AP)
Science	3 credits	3 credits	3 credits	4 credits (including honors and/or AP)
Social Studies	3 credits	3 credits	3 credits	4 credits (including honors and/or AP)
World Language	Not required	0-2 credits	2 credits at UW Madison (min)	3-4 credits including AP
Computers	Not required	Computer proficiency recommended	Will count toward academic preparation	Computer proficiency recommended
Fine Arts	Not required	Recommended	Will count toward academic preparation	1 or more credits recommended
Physical Education	1.5 credits	Not required	Not required	Not required
Health	0.5 credit	Not required	Not required	Not required
Financial Literacy	.5 credit	Not required	Not required	Not required
Electives	8.5 credits	Academic electives	4 academic electives from above areas	Academic electives recommended
<b>Total</b>	<b>24 credits</b>	<b>16-17 academic credits</b>	<b>17 or more academic credits</b>	<b>23 academic credits (average)</b>

### GHS Honor Roll (based on semester GPA)

Honors	High Honors	Special Honors
3.0-3.5	3.51-3.75	3.76 +

# REFLECTIVE QUESTIONS FOR STUDENTS

Throughout the Academic & Career Planning process, students are encouraged to reflect on four main questions to help develop their ACP.

<p style="text-align: center;"><b>KNOW</b> WHO AM I?</p>	<p>What interests me?</p> <ul style="list-style-type: none"> <li>● What are my strongest skills?</li> <li>● What academic, career, and/or life skills would I like to develop before I graduate?</li> </ul>
<p style="text-align: center;"><b>EXPLORE</b> WHAT DO I WANT TO DO?</p>	<ul style="list-style-type: none"> <li>● What are the Career Clusters I am most interested in and why?</li> <li>● What type of degree or certificate do I need to support my goals?</li> <li>● Will this career choice support what I want for my financial future?</li> <li>● Which internal and external courses can I take to explore my interests?</li> <li>● What jobs would I like to shadow and when will I do that?</li> </ul>
<p style="text-align: center;"><b>PLAN</b> HOW DO I GET THERE?</p>	<ul style="list-style-type: none"> <li>● What schools offer a related degree/major?</li> <li>● What will I need to provide a competitive admissions application for the schools/majors I might be interested in? For example:             <ul style="list-style-type: none"> <li>○ What level of math must I complete?</li> <li>○ Do I need to complete a portfolio?</li> <li>○ What ACT scores are required for admissions?</li> </ul> </li> <li>● In what areas will I pursue more rigorous coursework to support my strengths and/or areas of interest? Will I take AP courses etc.?</li> <li>● Will my credits transfer to the school(s) I want to attend?</li> <li>● How much do I anticipate that my post-secondary education might cost?</li> <li>● Will I qualify for Financial Aid and Scholarships?</li> <li>● Will I have the dispositions needed to find employment following high school?</li> </ul>
<p style="text-align: center;"><b>GO</b></p>	<p>Students are an active participant in their Academic &amp; Career Planning Process. Students are encouraged to reflect often on their choices and update their plans, sometimes more than yearly. This will include:</p> <ul style="list-style-type: none"> <li>● Reviewing, adapting, or modifying course selections and personal goals</li> <li>● Conferencing with counselors and/or parents</li> </ul>

# CAREER CLUSTERS

Career clusters are broad occupational groupings. Utilizing the 16 Career Clusters, students can identify pathways from high school to two and four-year colleges, graduate school or directly into the workforce. The links below will take you to individual career clusters which list GHS courses and activities that relate to a particular career area. Many courses have prerequisites - please see the course descriptions to help determine the proper sequencing. The courses are recommendations only and are not intended to direct students away from areas of interest. These recommendations are broad in order to match each career cluster, but not all courses are required for each occupation in that cluster. For more information about career choices and relevant courses, see your counselor.



Scan to see all  
Career Clusters

[AGRICULTURE & NATURAL RESOURCES](#)  
[ARCHITECTURE & CONSTRUCTION](#)  
[ARTS/AV TECHNOLOGY & COMMUNICATIONS](#)  
[BUSINESS MANAGEMENT & ADMINISTRATION](#)  
[EDUCATION & TRAINING](#)  
[FINANCE](#)  
[GOVERNMENT & PUBLIC ADMINISTRATION](#)  
[HEALTH SCIENCE](#)  
[HOSPITALITY & TOURISM](#)  
[INFORMATION TECHNOLOGY](#)  
[LAW, PUBLIC SAFETY, CORRECTIONS & SECURITY](#)  
[MANUFACTURING](#)  
[MARKETING](#)  
[SCIENCE, TECHNOLOGY, ENGINEERING & MATHEMATICS](#)  
[TRANSPORTATION, DISTRIBUTION & LOGISTICS](#)



## **Grafton High School/Regional Career Pathways**

Pathways Wisconsin is a regional approach to deliver high-quality state-endorsed regional career pathways in the state. Pathways Wisconsin has had tremendous success in bringing key partners together to create regional career pathways. GHS offers the pathways below. To be considered a Wisconsin Regional Career Pathway completer, a student must participate in 3 of 4 possible career exploration elements below:

### **ELEMENT 1 -**

Complete a Sequence of 3 Pathway Courses

### **ELEMENT 2 -**

Obtain an Industry-Recognized Certification

### **ELEMENT 3 -**

Participate in a Work-Based Learning Experience

### **ELEMENT 4 -**







Participate in a College Credit Opportunity

[Advanced Manufacturing Career Pathway](#)  
[Architecture & Construction Regional Career Pathway](#)  
[Business Administration in Finance Career Pathway](#)  
[Information Technology Regional Career Pathway](#)  
[Direct Patient Care Regional Career Pathway](#)



# THE 16 CAREER CLUSTERS

	<p>The production, processing, marketing, distribution, financing, and development of agricultural commodities and resources including food, fiber, wood products, natural resources, horticulture, and other plant and animal products/resources.</p>
	<p>Careers in designing, planning, managing, building and maintaining the built environment.</p>
	<p>Designing, producing, exhibiting, performing, writing, and publishing multimedia content including visual and performing arts and design, journalism, and entertainment services.</p>
	<p>Business Management and Administration careers encompass planning, organizing, directing and evaluating business functions essential to efficient and productive business operations.</p> <p>Business Management and Administration career opportunities are available in every sector of the economy.</p>
	<p>Planning, managing and providing education and training services, and related learning support services.</p>
	<p>Planning, services for financial and investment planning, banking, insurance, and business financial management.</p>
	<p>Executing governmental functions to include Governance; National Security; Foreign Service; Planning; Revenue and Taxation; Regulation; and Management and Administration at the local, state, and federal levels.</p>
	<p>Planning, managing, and providing therapeutic services, diagnostic services, health informatics, support services, and biotechnology research and development.</p>

	<p>Hospitality &amp; Tourism encompasses the management, marketing and operations of restaurants and other food services, lodging, attractions, recreation events and travel related services.</p>
	<p>Preparing individuals for employment in career pathways that relate to families and human needs.</p>
	<p>Building Linkages in IT Occupations Framework: For Entry Level, Technical, and Professional Careers Related to the Design, Development, Support and Management of Hardware, Software, Multimedia, and Systems Integration Services.</p>
	<p>Planning, managing, and providing legal, public safety, protective services and homeland security, including professional and technical support services.</p>
	<p>Planning, managing and performing the processing of materials into intermediate or final products and related professional and technical support activities such as production planning and control, maintenance and manufacturing/process engineering.</p>
	<p>Planning, managing, and performing marketing activities to reach organizational objectives.</p>
	<p>Planning, managing, and providing scientific research and professional and technical services (e.g., physical science, social science, engineering) including laboratory and testing services, and research and development services.</p>
	<p>Planning, management, and movement of people, materials, and goods by road, pipeline, air, rail and water and related professional and technical support services such as transportation infrastructure planning and management, logistics services, mobile equipment and facility maintenance.</p>

# COURSE PLANNING SHEET

9th Grade	
Course	Credit
<b>Required:</b>	
Literature/Composition 9 or Literature/Composition 9 Honors	1
Mathematics: _____	1
Biology or Biology Honors	1
Global Studies or AP Human Geography	1
Physical Education 9	.5
Health	.5
<b>Career Exploratory Electives:</b>	
_____	___
_____	___
_____	___
_____	___

10th Grade	
Course	Credit
<b>Required:</b>	
American Lit/Comp 10 or American Lit/Comp 10 Honors	1
Mathematics: _____	1
Science: _____	1
US History or AP US History	1
Phy Ed: _____	.5
<b>Career Exploratory Electives:</b>	
_____	___
_____	___
_____	___
_____	___
_____	___
_____	___

11th Grade	
Course	Credit
<b>Required:</b>	
World Literature/Composition or A.P. Language and Composition	1
Mathematics: _____	1
Science: _____	
Social Studies _____	
Physical Education (either in 11 or 12 grade)	.5
<b>Career Exploratory Electives:</b>	
_____	___
_____	___
_____	___
_____	___

12th Grade	
Course	Credit
<b>Required:</b>	
English: _____	1
<b>Career Exploratory Electives:</b>	
_____	___
_____	___
_____	___
_____	___
_____	___
_____	___

*\*Financial Literacy .5 credit requirement must be completed prior to graduation.*

*\*\* American Government .5 credit requirement must be completed prior to graduation.*

# Grafton High School Courses

\*Prerequisite required

Prerequisite	ART	Credit	9	10	11	12
	ART EXPLORATION	0.5	x	x	x	x
*	AP ART & DESIGN	1			x	x
	CERAMICS 1	0.5	x	x	x	x
*	CERAMICS 2	0.5	x	x	x	x
*	CERAMICS 3	0.5		x	x	x
	DIGITAL ARTS 1	0.5		x	x	x
*	DIGITAL ARTS 2	0.5		x	x	x
	DRAWING 1	0.5	x	x	x	x
*	DRAWING 2	0.5	x	x	x	x
*	DRAWING 3	0.5		x	x	x
*	JEWELRY METALS 1	0.5	x	x	x	x
*	JEWELRY METALS 2	0.5		x	x	x
*	PAINTING 1	0.5	x	x	x	x
*	PAINTING 2	0.5		x	x	x
*	PAINTING 3	0.5		x	x	x
	BUSINESS	Credit	9	10	11	12
	ACCOUNTING	1		x	x	x
*	ADV ACCOUNTING	1			x	x
	BUSINESS & MERCHANDISING	1	x	x	x	x
	CAPP ENTREPRENEURSHIP	0.5		x	x	x
	CAREER INTERNSHIP	.5/1			x	x
	COLLEGE PERSONAL FINANCE	0.5		x	x	x
	COMPUTER APPL FOR COLLEGE & CAREERS	0.5	x	x	x	x
	DESKTOP PUBLISH	0.5	x	x	x	x
	DIGITAL VIDEO DESIGN	1	x	x	x	x
	GAME/APP DESIGN	0.5	x	x	x	x
	PERSONAL FINANCE	0.5		x	x	x
	SPORTS MANAGEMENT	0.5		x	x	x
	WEB DESIGN	0.5	x	x	x	x
	COMPUTER SCIENCE	Credit	9	10	11	12
	INTRO TO PROGRAMMING	1	x	x	x	x
*	ADVANCED COMPUTER PROGRAM./VIRTUAL REALITY	1		x	x	x
*	AP COMP SCIENCE A	1		x	x	x
*	AP COMP SCIENCE PRIN	1		x	x	x
	COMMUNICATION ARTS	Credit	9	10	11	12
	AMER LIT/COMP	1		x		
	AMER LIT/COMP HON	1		x		
	AP ENGLISH LANG	1			x	x
	AP ENGLISH LIT	1				x
	AP SEMINAR	1		x	x	x
*	AP RESEARCH	1			x	x
	CONTEMPORARY LIT	0.5			x	x

	COMMUNICATIONS	0.5			x	x
	CREATIVE WRITING	0.5			x	x
	COLLEGE COMP	0.5				x
	LIT & COMP 9	1	x			
	LIT & COMP 9 HONORS	1	x			
	LIT AS SOC REFL	0.5			x	x
	PUBLICATION DES PR. I	1		x	x	x
*	PUBLICATION DES PR II	1			x	x
	TECH WRIT/COMP	0.5				x
	WORLD LIT/COMP	1			x	
	FAMILY CONSUMER SCIENCE	Credit	9	10	11	12
**	ADV FOOD & RESTAURANT MGMT	1.0			x	x
	CHILD DEV 1	0.5			x	x
*	CHILD DEV 2	0.5			x	x
	BAKING PRINCIPLES	0.5	x	x	x	x
	FASHION/FABRICS 1	0.5	x	x	x	x
*	FASHION/FABRICS 2	0.5	x	x	x	x
*	FOOD CONCEPTS	0.5	x	x	x	x
*	FOOD SCIENCE	0.5		x	x	x
	HOUSING/DESIGN	0.5		x	x	x
	INTRO TO HEALTH OCCUPATIONS	0.5		x	x	x
	INDEPENDENT LIVING	0.5			x	x
	WORLD LANGUAGE	Credit	9	10	11	12
*	CHARLEMOS	0.5			x	x
	GERMAN 1	1	x	x	x	x
*	GERMAN 2	1	x	x	x	x
*	GERMAN 3	1		x	x	x
*	GERMAN 4	1			x	x
*	AP GERMAN LANGUAGE/GERMAN 5	1				x
*	HISP FILM & LIT	0.5				x
*	LATIN AM STUDIES	0.5			x	x
*	AP SPANISH LANG	0.5				x
	SPANISH 1	1	x	x	x	x
*	SPANISH 2	1	x	x	x	x
*	SPANISH 3	1		x	x	x
*	SURPRISING SPAIN	0.5			x	x
	TECH & ENGINEERING	Credit	9	10	11	12
*	ADVANCED AUTO	1				x
*	ADV MACH TOOL	0.5		x	x	x
	ARCH DESIGN 1	0.5		x	x	x
*	ARCH DESIGN 2	0.5		x	x	x
*	AUTO DIAGNOSIS	0.5			x	x
	AUTO SERVICE	0.5		x	x	x
*	CABINETMAKING	0.5		x	x	x
*	AIR COOLED ENGINES	0.5		x	x	x
	MACH TOOL TECH	0.5		x	x	x
	METAL FABRICATION	0.5		x	x	x
	PLTW: PRIN OF ENGIN	1		x	x	x
	PLTW: INTRO TO ENGINEERING DESIGN	1	x	x	x	x
	PLTW: COMP INT MFG	1		x	x	x

<b>TECH &amp; ENGINEERING</b>		Credit	9	10	11	12
*	PLTW: ENGINEERING DESIGN & DEVELOPMENT	1			x	x
*	RES CONSTRUCT 1	0.5			x	x
*	RES CONSTRUCT 2	0.5			x	x
	FTC: ROBOTICS	.5	x	x	x	x
	SYSTEMS REPAIR	1				x
	TECH/ENGINEER 9	1	x			
	WELDING 1	0.5		x	x	x
*	WELDING 2	0.5		x	x	x
	WOOD DESIGN	0.5		x	x	x
<b>MATH</b>		Credit	9	10	11	12
*	ALGEBRA 2	1	x	x	x	x
*	ALGEBRA 2 HONORS	1	x	x	x	x
*	ALGEBRA	1	x	x	x	x
	ALGEBRA SUPPORT	1	x			
*	AP CALCULUS AB	1			x	x
*	AP CALCULUS BC	1			x	x
	AP PRECALCULUS	1		x	x	x
	AP STATISTICS	1			xx	x
*	INTRO COLLEGE ALG/TRG	1			x	x
*	GEOMETRY	1	x	x	x	x
	GEOMETRY SUPPORT	1		x	x	
*	GEOMETRY HONORS	1	x	x	x	x
<b>MUSIC</b>		Credit	9	10	11	12
*	AP MUSIC THEORY	0.5		x	x	x
	CAMERATA	1		x	x	x
	CHORALE	1	x	x	x	x
	CONCERT BAND	1	x	x	x	x
	CONCERT CHOIR	1		x	x	x
	FUND OF THEATER	0.5			x	x
	MUSIC THEORY	0.5		x	x	x
	MUSIC APPRECIATION	0.5	x	x	x	x
	JAZZ ENSEMBLE	0.5	x	x	x	x
	WIND ENSEMBLE	1		x	x	x
<b>PHYSICAL EDUCATION</b>		Credit	9	10	11	12
	PHY ED 12	0.5				x
	PHY ED 9	0.5	x			
	NET GAMES	0.5		x	x	x
	PERSONAL FITNESS	0.5		x	x	x
	STRENGTH TRAINING	0.5		x	x	x
*	ADV. STRENGTH TR.	0.5		x	x	x
	TEAM SPORTS	0.5		x	x	x
*	OFFICIATING	0.5		x	x	x
	OUTDOOR ADVENTURE	0.5		x	x	x
	PHY ED LEADERS	0.5		x	x	x
<b>HEALTH</b>		Credit	9	10	11	12
	HEALTH	.5	x			

<b>SCIENCE</b>		Credit	9	10	11	12
*	AP BIOLOGY	1.5			x	x
*	AP CHEMISTRY	1.5			x	x
*	AP ENVIRON SCIENCE	1			x	x
*	AP PHYSICS 1	1			x	x
	BIOLOGY	1	x			
	BIOLOGY HONORS	1	x			
*	INTRODUCTION TO MATERIALS SCIENCE	0.5		x	x	
*	CHEMISTRY HONORS	1		x	x	x
*	CHEMISTRY	1		x	x	x
	ENVIRON SCIENCE	0.5		x	x	x
	GEOLOGY/EARTH SYST	0.5		x	x	x
	PLTW:HUMAN BODY	1		x	x	x
	PLTW:BIOMED INNO	1			x	x
	PLTW:MED INTERV	1			x	x
	PLTW:BIOMED SCI	1	x	x	x	x
	PHYSICS	1		x	x	x
	SPACE SCIENCES	0.5		x	x	x
*	ZOOLOGY/BOTANY	0.5		x	x	x
<b>SOCIAL STUDIES</b>		Credit	9	10	11	12
	AMERICAN GOV	0.5		x	x	x
*	AP HUMAN GEOG	1	x			
	GLOBAL STUDIES	1	x			
	AMERICAN ISSUES	0.5		x	x	x
	ANCIENT HISTORY	0.5			x	x
	AP PSYCHOLOGY	1			x	x
*	AP U.S. HISTORY	1		x		
	WORLD ISSUES	0.5			x	x
	AP MACROECON	0.5			x	x
*	AP MICROECON	0.5			x	x
	GEOGRAPHY	0.5		x	x	x
	INTRO TO EDUCATION	.5			x	x
	MEDIEVAL HIST	0.5			x	x
	REVOLUTIONS	0.5		x	x	x
	SOCIOLOGY	0.5		x	x	x
	U.S. HISTORY	1		x		
<b>YOUTH APPRENTICESHIP</b>		Credit	9	10	11	12
	AUTO APPRENTICE	1			x	x
	COMPUTER APPREN	1			x	x
	ENG/DESIGN APPR	1			x	x
	BANK APPRENTICE	1			x	x
	HEALTH APPRENTI	1			x	x
	HOSP/TOUR APPR	1			x	x
	MFG INDUST APPR/STEM	1			x	x
	STEM APPR	1			x	x

# GRAFTON HIGH SCHOOL ACADEMIC OPPORTUNITIES

## **ADVANCED PLACEMENT COURSES**

Advanced Placement is a program of college level courses and exams that give high school students the opportunity to receive advanced placement and/or credit in college. Advanced Placement courses are taught by GHS staff and are weighted 1 extra grade point. In May, the student has the option to take the Advanced Placement test in that subject area. Note: Students may also take the AP exam without taking the related GHS AP course.

More information on AP Courses can be found [here](#).

Grafton High School offers the following AP courses:

AP Art & Design (2D, 3D & Drawing)  
AP Biology  
AP Calculus AB  
AP Calculus BC  
AP Chemistry  
AP Computer Science A  
AP Computer Science Principles  
AP English Language & Composition  
AP English Literature & Composition  
AP Environmental Science  
AP German Language & Culture  
AP Human Geography



AP Macroeconomics  
AP Microeconomics  
AP Music Theory  
AP Physics I: Algebra Based  
AP Precalculus  
AP Psychology  
AP Research  
AP Seminar  
AP Statistics  
AP Spanish Language & Culture  
AP U.S. History

## **EARLY COLLEGE CREDIT PROGRAM (ECCP)**

This program allows a student in grades 9 through 12 to enroll in a UW System institution, or a private, non-profit institution of higher education, to take one or more nonsectarian courses. Students may earn high school credit, postsecondary credit, or both, if there is not a comparable or current course offered by the district. The deadline to submit an application is March 1st for the fall and October 1 for the spring semester. See the college website for application. Students who have questions about the program should see their school counselor or visit the GHS Counseling [website](#).

## **START COLLEGE NOW**

This program allows high school students the opportunity to take college courses at Wisconsin Technical Colleges. Applications are available on the DPI and Technical College System website. The deadline to submit an application is March 1st for the fall and October 1 for the spring semester. Students who have questions about the program should see their school counselor or visit the GHS Counseling [website](#).



## **YOUTH APPRENTICESHIP**

**Credit:** .5 credit each semester for the industry-related course and .5 credit each semester for the work experience component

**Grades:** 11 & 12

**Prerequisite:** Meet eligibility criteria; complete the application process; selection is by industry representatives

[Youth Apprenticeships](#) are unique opportunities to start preparing for a career while still in high school. One-year and two-year programs combine academic education, occupational instruction and work-based learning with an employer. Apprenticeships are offered in the following areas and can be taken one or two years. More information can be found at [Ozaukee Youth Apprenticeship](#).

[Agriculture](#)  
[Architecture & Construction](#)  
[Art, A/V Technology & Communications](#)  
Business Administration  
Education

[Finance](#)  
[Health Science](#)  
[Hospitality, Lodging & Tourism Information](#)  
[Technology](#)

[Manufacturing](#)  
[Marketing](#)  
[Science, Tech, Engineering & Mathematics \(STEM\)](#)  
[Transport, Dist. & Logistics](#)

## **GHS DUAL CREDIT COURSES**

Grafton High School has articulated agreements with various post-secondary institutions around the state, allowing our students the opportunity to earn college credit. For a student to gain college-level credit, certain requirements must be met by the student. Students should contact the instructor of the GHS course to learn more about how these credits can be earned. Below is a list of the courses with current agreements.

<b>GHS Department/Course</b>	<b>College</b>	<b>College Course #</b>	<b>College Credits</b>	<b>Type</b>
<b>Business</b>				
Accounting	MATC	ACCTG-102	3	T.C.
Advanced Accounting	MATC	ACCTG-111	4	T.C.
Business & Merchandising	MATC	BADM-134	3	T.C.
CAPP: Entrepreneurship	UW Oshkosh (CAPP)	BUS-198	3	T.C.
College Personal Finance	UW Oshkosh (CAPP)	BUS-231	3	T.C.
Computer Applications for College & Careers	MATC	COMPSSW-106	3	T.C.
Desktop Publishing	MATC	GRDS-110	3	T.C.
Web Page Design	MATC	WEBDEV-119	3	T.C.
<b>Family &amp; Consumer Science</b>				
Advanced Foods & Restaurant Management	MATC	CULMGT-112	2	T.C.
Child Development 1	MATC	CHILDD-148	3	T.C.
Child Development 2	MATC	CHILDD-110	3	T.C.
<b>Social Studies</b>				
Intro to Education	UW Oshkosh (CAPP)	ESED-110	3	T.C.
<b>Science</b>				
PLTW: Biomedical Innovations	<a href="#">Varies</a>			T.C.
PLTW: Principles of Biomedical Science*	<a href="#">Varies</a>			T.C.
PLTW: Human Body Systems*	<a href="#">Varies</a>			T.C.
PLTW Medical Intervention*	<a href="#">Varies</a>			T.C.
<b>Technology &amp; Engineering</b>				
Auto Service	FVTC	MLR 1	4	T.C.
Advanced Autos	FVTC	MLR 2-4	12	T.C.
PLTW: Intro to Engineering Design	UW Green Bay		2	T.C.
PLTW: Principles of Engineering	UW Green Bay		3	T.C.
PLTW: Computer Integ. Manf.	UW Green Bay		3	T.C.
PLTW Engineering Des. & Dev.	UW Green Bay		2	T.C.
<b>World Language</b>				
AP Spanish Lang. & Culture and 1 of the 2 culture classes	UW Green Bay	Spanish 202	14	T.C.
AP German Lang. & Culture	UW Green Bay	German 202	14	T.C.

\*Students can work with multiple universities which issue college credit for PLTW courses taken in high school. See the GHS PLTW teachers for more information.

**T.C.** (Transcribed Credit) = Upon completion of a GHS course, students will receive credit for a college equivalent course that will be placed on the respective college transcript for that student. *Upon completion of the dual credit courses, students will need to contact the issuing college to obtain a copy of the post-secondary transcript.*

**CAPP**-The Cooperative Academic Partnership Program at the University of WI Oshkosh provides academically eligible high school students the opportunity to earn college credits while still in high school. Students may earn dual credit at UW Oshkosh, providing they meet **one** of the following requirements: Click [here](#) to see which colleges have accepted CAPP credit.

- Class rank in the top 30 percent
- GPA of 2.75 or above (on a 4.0 scale)

**UW Green Bay College Credit in High School (CCIHS)** program offers the following options for students taking World Language courses: Complete your CCIHS course and earn a B grade or better to earn 11 retroactive credits plus the 3 transcribed credits. Complete your CCIHS course and earn a B/C or a C grade and receive 5.5 retroactive credits plus the 3 transcribed credits.



indicates an Industry Recognized Certificate is available

## Industry-Recognized Credentials

**Industry-recognized credentials (IRC)** are certifications, credentials, or licenses that are vetted by employers and serve to recognize skill attainment needed for recruitment, screening, hiring, retention, advancement, or to mitigate workforce shortages. The IRC is endorsed by a nationally recognized trade association or an organization in a particular industry. An IRC is a verification of a students' qualification or competence through a technical education program.

### **Course Name**

Advanced Foods & Restaurant Management  
Business & Merchandising  
CAPP Entrepreneurship  
Career Internship  
College Personal Finance  
Computer Apps  
Digital Video (Independent Study)  
Metals Fabrication  
PLTW (Any Engineering Course)  
PLTW: Computer Integ. Manufacturing  
Residential Construction  
Systems Repair/Adv. Auto.

### **Certification Name**

Servsafe Certification  
ASK Fundamental Business Concepts  
ASK Concepts of Entrepreneurship & Management  
Wisconsin Employability Skills Certificate  
ASK Concepts of Finance  
Microsoft Office Specialist  
TRUST Drone Certification  
NIMS  
AutoDesk Fusion 360  
NIMS  
Career Connections - Level 3 Certificate  
Automotive Service Excellence (ASE) Certification

## **ADDITIONAL PLANNING INFORMATION**



### **REQUIRED COURSE LOAD**

Each student shall be enrolled in a minimum of seven credits per year. Exceptions to this include:

1. Seniors enrolled in an approved Work Study Program
2. Students enrolled in a Youth Apprenticeship Program
3. Students with an IEP or a 504 Plan
4. Students identified as At-Risk

### **CHANGES IN COURSE SELECTION**

Students are expected to choose their courses carefully while considering their Academic and Career Plan. Below is the timeline if a schedule change is deemed necessary:

- Students who are requesting to add or drop a class for a legitimate reason must have parent permission and see their school counselor within the **first five school days of the semester**.
- Students who do not have a study hall (8 courses) will have through the **first four weeks of each semester** to drop a course for a study hall.

### **GRADUATION PARTICIPATION**

Students must meet all graduation requirements to participate in the graduation ceremony.

### **EARLY GRADUATION**

The Board acknowledges that some students are pursuing educational goals which include graduation from high school earlier than their designated class. The process and timeline outlined below must be followed to be considered for approval.

1. A student may graduate after seven semesters by earning 24 total credits; earn all 13 required course credits, and receive the permission of the Principal before the end of the sixth semester.
2. A student may graduate after six semesters of high school by earning 24 credits; earn all 13 required course credits, and receive the permission of the Principal. The request form must be submitted along with junior year scheduling materials.





## **NCAA COLLEGE STUDENT ATHLETES**

Student-athletes wishing to compete in athletics at division 1 or 2 institutions, (athletic scholarship schools) need to register with the National Collegiate Athletic Association Clearinghouse. Registration forms and information describing regulations and eligibility can be obtained by visiting the Clearinghouse [website](#). **Eligible students must check to see whether the high school courses that are being requested are NCAA approved courses.** See your coach or school counselor for additional information. All students wishing to be a student-athlete in college should also be familiar with this website: [Official Site of the NCAA](#).

## **TEACHER ASSISTANT & INDEPENDENT STUDY**

**Teacher Assistant position** - For students interested in assisting a teacher, there is an opportunity to be a teacher assistant. Interested upperclassmen (juniors and seniors) must discuss this possibility with the content teacher prior to securing administrative approval. Applications are available in the GHS Counseling Office. Teacher Assistant positions are graded on a pass/fail basis and awarded .5 credit per semester. **Students can not have a study hall in addition to a Teacher Assistant position.**

**Independent Study** - Students who are in 11th or 12th grade wishing to pursue study beyond established curricular offerings may apply for an Independent Study for elective credit to replace a study hall. The process involves completion of the Independent Study Plan form available in the GHS Counseling Office which requires parent, supervising teacher, counselor, and principal approval. Planning for an Independent Study should take place prior to the start of the semester in which the Independent Study will occur. It is expected that the Independent Study student will give a presentation at the end of the semester. Independent Study courses are graded on a pass/fail basis and awarded a .5 credit per semester.



## **Xello**

Xello is an online program that fully engages every student in building the skills, knowledge, and plans for future success — regardless of background, ability, or pathways. It is a comprehensive tool that is accessible to all students and parents for college and career planning. Xello is where your Academic & Career Plan (ACP) is created, stored and monitored. Xello can be accessed by going to the GHS website under student links. For questions about Xello or ACP, please consult your school counselor, who is able to assist you.

---

## **GLOBAL SCHOLARS CERTIFICATE**

Grafton High School offers a [Global Education Achievement Certificate](#) to high school students who have demonstrated a strong interest in global citizenship by successfully completing a global education curriculum and engaging in cocurricular activities and experiences that foster the development of global competencies. It encourages students to enroll in classes with global content in the arts, sciences, and humanities, and prepares globally competent students who are career ready.

Students may earn a Global Education Achievement Certificate by meeting the following criteria:

- 4 credits of world language in high school, earning a grade of B or better
- 4 credits of additional courses (see list below)
- participate in service or international extracurricular activities
- 8 reflections on international/cultural media (books, movies, lectures, art, and literature)
- provide a minimum of 20 hours of community service with a global emphasis.

In addition to world language, students must take 4 additional credits from the following list:

<b>Business</b>	Business & Merchandising
<b>Social Studies</b>	AP Human Geography, AP Microeconomics, AP Macroeconomics, World Issues, Geography, Ancient History, Medieval History, Revolutions, Global Studies
<b>Science and Technology:</b>	Environmental Science, AP Environmental Science, AP Computer Science Principles, PLTW: Principles of Engineering,
<b>English</b>	World Literature Comp. AP Literature and Composition, AP Research, AP Seminar
<b>Music &amp; Visual Arts:</b>	Art Exploration, Drawing 1, Painting 1, Digital Arts1 & 2, Concert Band, Wind Ensemble, Concert Choir, Chorale, Camerata, AP Music Theory

*Students must also participate in 4 of the following clubs or trips/exchanges:*

Amnesty International	German Club	Spanish Club	Personal Trip Abroad	Jazz Ensemble
Chamber Singers	Art Club	GHS Art Trip	Exchange Program	Military Book Club
FBLA	Leo Club	GHS Sponsored trips	(hosting or living abroad)	Model UN

# ART

## Grade 9

## Grades 10-12

## Grades 11-12

Art  
Exploration  
9,10,11,12  
.5 credit

Drawing 1  
9,10,11,12  
.5 credit

Drawing 2  
9,10,11,12  
.5 credit

Drawing 3  
10,11,12  
.5 credit

Painting 1  
9,10,11,12  
.5 credit

Painting 2  
10,11,12  
.5 credit

Painting 3  
10,11,12  
.5 credit

Digital Arts  
1  
10,11,12  
.5 credit

Digital Arts  
2  
10,11,12  
.5 credit

AP Art & Design\*  
11,12  
1 credit

Ceramics 1  
9,10,11,12  
.5 credit

Ceramics 2  
9,10,11,12  
.5 credit

Ceramics 3  
10,11,12  
.5 credit

Jewelry  
Metals 1  
9,10,11,12  
.5 credit

Jewelry  
Metals 2  
10,11,12  
.5 credit

No  
Prerequisite

### \*AP Requirements

**Drawing Portfolio:** Drawing 1, Painting 1 and 2 other classes

**2D Portfolio:** Drawing 1, Painting 1 and 2 other art courses or Digital Arts 1, Digital Arts 2 and 2 other Art courses

## **AP Art & Design**

**Credit: 1**

**Level: 11, 12**

**Prerequisites:**

- **Drawing Portfolio: Drawing 1, Painting 1, and two semesters of art courses**
- **2D Portfolio: Drawing 1, Paint 1, and two semesters of art courses OR Digital Arts 1 & Digital Art 2, and two semesters of art courses**

**Fees: \$17.00 for materials \$97.00 for the AP Exam (optional)**

This course is for a mature student who has maintained a strong interest in art throughout high school. Work will require a high level of self motivation and a level of dedication beyond that of previous art classes. AP Studio Art will guide you to develop and refine your personal esthetic as well explore new media and techniques. During this process you will develop a portfolio of work that fulfills the AP Board requirements in the areas of quality, concentration and breadth. The portfolios may be in 2D, 3D or Drawing. Prompts, resources, critiques and weekly reviews of your work will be structured into the course, allowing creative freedom to explore, while having benchmarks and deadlines to keep you on task, keeping in mind artistic pursuits toward a sophisticated portfolio of work, worthy of Advanced Placement college credit.

## **Art Exploration**

**Credit: .5**

**Level: 9, 10, 11, 12**

**Fees: \$4.00**

Students creatively and visually solve specific problems based on a set of criteria while experimenting and engaging both traditional and nontraditional art techniques. Students also research contemporary and historical artists and genres, share research, and articulate their analysis of visual issues through their evolution of artistic ideas and concepts. Students build a creative toolbox of concepts, skills and techniques that will continue to grow as applied to visual communication and problem solving for future art courses.

## **Ceramics 1**

**Credit: .5**

**Level: 9, 10, 11, 12**

**Fees: \$15.00 for materials**

This course will focus on hand-building techniques and the proper use of tools and equipment specific to ceramics. The student will further the development of personal ideas and artistic themes, skills as applied to clay while creating 3D structures with a variety of techniques exercising creative thinking skills.

## **Ceramics 2**

**Credit: .5**

**Level: 9, 10, 11, 12**

**Prerequisite: Ceramics 1**

**Fees: \$15.00 for materials**

This course will focus on learning to throw pots on the potter's wheel. Students will create a series of vessels with different themes and functions. The student will further the development of personal ideas and artistic themes, develop knowledge, skills, and understanding of clay as it is formed on a potter's wheel.

## **Ceramics 3**

**Credit: .5**

**Level: 10, 11, 12**

**Prerequisite: Ceramics 2**

**Fees: \$15.00 for materials**

This course is for a mature student with a strong interest in art and ceramics. Work will require self-motivation and strong creative thinking skills. Students will specialize in a specific body of work and design projects to meet the instructor's criteria. The student will develop a masterful understanding and in-depth knowledge of ceramics and 3D forms. Students will broaden their ability to effectively use art history, analysis, creative thinking, and evaluation to improve and create works of sophistication.

## **Digital Arts 1**

**Credit: .5**

**Level: 10, 11, 12**

This introduction course teaches students how to use Adobe CC to creatively solve artistic design problems. They will learn to create vector images using Adobe Illustrator where students will learn the basics of marketing, branding. Students will work on projects for the community and the school in a professional manner. In Photoshop, they will explore how to create and alter raster images through photography. This course will provide students with an introduction of current digital photo technology as a fine art, documentary, and social media tool. Students will end the class with a Digital Art Portfolio for both graphic based imagery and photography based imagery.

## **Digital Arts 2**

**Credit: .5**

**Level: 10, 11, 12**

**Prerequisite: Digital Arts 1**

This course is a continuation of using Adobe CC to creatively solve artistic design problems. Students will learn to express meaning by exploring and using the basic knowledge of shape and space, unity and components such as contrast, hierarchy, psychology of color, and sign and symbol. Students will use available traditional and digital media and work within design constraints. Students will additionally work on projects for the community and the school in a professional manner. They will be exploring Adobe Photoshop and Illustrator using traditional digital tools and digital photography to build their digital portfolio.

## **Drawing 1**

**Credit: .5**

**Level: 9, 10, 11, 12**

**Fees: \$7.00**

Students will develop a better understanding of drawing techniques as well as experiment with a variety of drawing mediums such as: pencils, charcoal, pastels, oil pastels, pen & ink and markers. Students will expand on drawing techniques studied in foundations and be encouraged to think creatively and build observational skills to improve hyper-perceptive observation and drawing skills.

## **Drawing 2**

**Credit: .5**

**Level: 9, 10, 11, 12**

**Prerequisite: Drawing 1**

**Fees: \$7.00**

Study will focus on drawing the human form while exploring new styles of drawing. Students will be expected to combine well crafted drawings with creative thinking skills to solve challenging visual problems. Some of the media used may include pen and ink, charcoal, graphite, colored pencil, pastel and marker. Students will further advance their understanding and ability to draw using various techniques, media, and creative thinking skills.

## **Drawing 3**

**Credit: .5**

**Level: 10, 11, 12**

**Prerequisite: Drawing 2**

**Fees: \$7.00**

This course is for a mature student with a strong interest in art and drawing. Work will require self-motivation and strong creative thinking skills. In this course the student will be exploring new types of drawing as well as further developing craftsmanship and personal drawing style. Students will develop a masterful understanding of drawing with any media and a strong ability to think creatively and apply ideas in a meaningful way.

## **Jewelry Metals 1**

**Credit: .5**

**Level: 9, 10, 11, 12**

**Prerequisite: Art Exploration or Drawing 1**

**Fees: \$15.00 for materials**

Students will investigate skills and techniques to create different types of jewelry using brass, copper, nickel metals. Exploring different techniques including riveting, hard soldering, texturing and patinas as well as the proper use of tools and equipment. The student will further the development of personal ideas and artistic themes, applying creative thinking skills.

## **Jewelry Metals 2**

**Credit: .5**

**Level: 10, 11, 12**

**Prerequisite: Jewelry Metals 1**

**Fees: \$15.00 for materials**

Students will focus on jewelry forming and refining techniques such as enameling, forging, welding, acid etching, raising sheet metal, and forming techniques. While continuing to use riveting, hard soldering, texturing and patinas within their work. The student will further the development of personal ideas and artistic themes, skills, and understanding of jewelry metal techniques.

## **Painting 1**

**Credit: .5**

**Level: 9, 10, 11, 12**

**Fees: \$10**

**Prerequisite: Drawing 1**

Students will focus on developing a basic understanding of painting techniques, color and how to use tools such as a pallet knife and various types of bristle brushes. The course investigates historical and contemporary color techniques and theory, using Tempera, acrylic and watercolor paints. Students must have a set of brushes or they may be purchased for \$11.

## **Painting 2**

**Credit: .5**

**Level: 10, 11, 12**

**Prerequisite: Painting 1**

**Fees: \$10**

In this course the student will continue to explore different types of painting techniques for creating dynamic compositions. Students may work with tempera, acrylic, latex, oil, watercolor, spray paint or mixed media. Painting subjects will include abstraction, landscape, still life, and portraiture. Students must have a set of brushes or they may be purchased for \$11.

## **Painting 3**

**Credit: .5**

**Level: 10, 11, 12**

**Prerequisite: Painting 2**

**Fees: \$10**

This course is for students with a strong interest in art and painting. Work will require self-motivation and strong creative thinking skills. Painting subjects will vary depending on students' interests and will be tailored by the teacher for each project. The student will develop a masterful understanding of painting in various styles along with a strong ability to think creatively and apply ideas in a meaningful way. Students must have a set of brushes or they may be purchased for \$11.



**VISUAL  
ARTS**

# BUSINESS & INFORMATION TECHNOLOGY

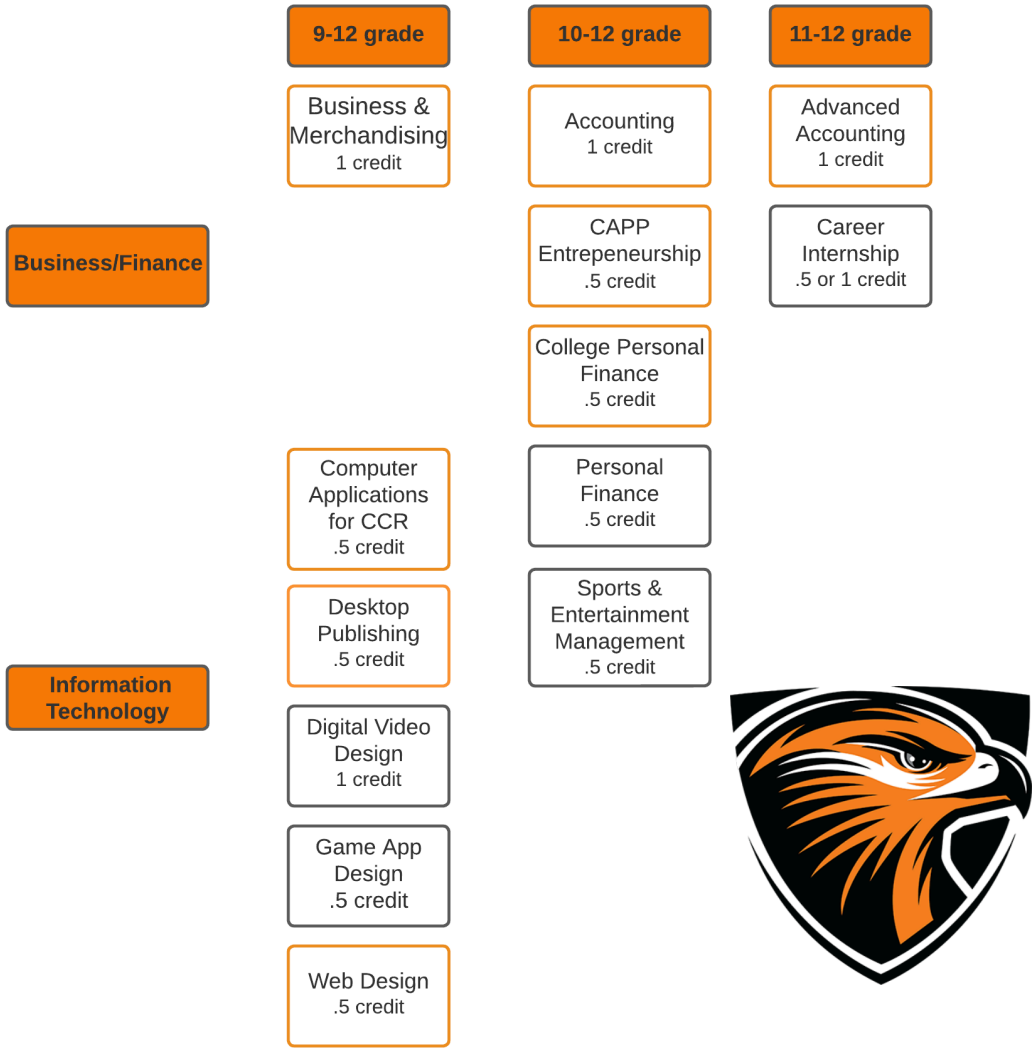

\*\*\*Can earn college credit in this class.

*Sample Business/Finance Pathways*

**Business Merchandising--Accounting--Advanced Accounting--Career Internship**

**Business Merchandising--Sports & Ent. Mgmt.--College Personal Finance--CAPP Entrepreneurship**

## Accounting

**Credit: 1**

**Level: 10, 11, 12**

**Math Credit:** *This course may be used as the 3<sup>rd</sup> math credit for graduation but most colleges won't recognize it as a college prep math credit.*

**MATC Transcribed Course ACCTG102 (3 credits)**

Get ready to embark on a financial adventure like no other! Accounting 101 is not just a course; it's your passport to decoding the financial mysteries that shape the business landscape. This dynamic journey will empower you with the foundational knowledge and practical skills to navigate the world of accounting with confidence and flair.

By the end of Accounting 101, you'll not only have a solid grasp of financial fundamentals but also the confidence to navigate the intricate web of business finances. Join us in unraveling the captivating world of accounting, where every debit has its credit, and financial fluency becomes your superpower!

## Advanced Accounting

**Credit: 1**

**Level: 11, 12**

**Prerequisite: Accounting**

**MATC Transcribed Course ACCTG111 (4 credits)**

Throughout this course, students will embark on a journey through advanced topics such as Cash and Accrual Accounting, Partnership Accounting, Departmentalized Accounting, General Accounting Adjustments, and Corporate, Cost, and Managerial Accounting. This isn't your ordinary accounting class – we're here to explore the depths of financial intricacies and unveil the exciting opportunities that await in the field.

As a highlight, students will actively engage in the Hawks' Nest, where they will be at the forefront of tracking financials using cutting-edge tools like the Square register system. But that's not all – we're taking it a step further by immersing ourselves in the world of QuickBooks software. Through hands-on experience, students will master the art of managing financial data efficiently, a skill that is invaluable in today's fast-paced accounting landscape.

Get ready for a course that not only broadens your accounting knowledge but also equips you with practical skills that employers demand. Join us on this dynamic journey through Advanced Accounting, where we're not just crunching numbers; we're shaping future accounting leaders who can navigate the complexities of the financial world with confidence and expertise.

## Business & Merchandising

**Credit: 1**

**Level: 9, 10, 11, 12**

Get ready to supercharge your business acumen! In this exciting journey, students will not only dip their toes but dive headfirst into foundational business skills. We're talking Business Management, Operations, Law, Communications, International Business, Marketing, and Merchandising – the whole business buffet! But wait, there's more! This isn't your typical lecture; this course is a high-energy collaboration extravaganza. Get ready to team up with your fellow business enthusiasts as we tackle projects that'll make your brain cells do the cha-cha.

And guess what? We're not just talking theory here; we're diving into the real deal. Brace yourself for the ultimate Hawks' Nest experience. Picture this: you and your team making strategic decisions about what products to sell, setting prices that make the cash register sing, designing the store layout that'll make customers do a double-take, and that's just the tip of the business iceberg! So, buckle up for a hands-on, minds-on adventure where you won't just learn about business; you'll be running one. Welcome to the business rollercoaster, it's going to be a wild ride!

## CAPP Entrepreneurship

**Credit: .5**

**Level: 10, 11, 12**

**Fees: If taken for college credit, approximately \$315 for 3 college credits. College credit is available through UW-Oshkosh Cooperative**

Welcome to the thrilling world of CAPP Entrepreneurship, a high-octane, college-level business class that mirrors the standards set by the University of Wisconsin-Oshkosh (UW-Oshkosh). Get ready to unleash your entrepreneurial spirit as we dive into an immersive journey of discovery, equipping you with the savvy and skills to conquer the dynamic realm of business. This isn't just a class; it's an adventure where learning comes to life through a fusion of cutting-edge theories and hands-on, real-world projects.

But that's not all—brace yourself for the Homecoming T-shirt Project, where you won't just be making cool shirts; you will be selling them for a profit. This class isn't just about learning; it's about earning and turning your entrepreneurial dreams into reality. Join us on this electrifying journey and let the adventure begin!



## Career Internship

**Credit:** .5 or 1  
**Level:** 11, 12

Welcome to the High School Career Internship Experience, a transformative course designed to provide students with a hands-on introduction to the world of work and valuable insights into various career pathways. This course empowers students to explore their interests, gain practical experience, and develop essential professional skills in a real-world setting.

Throughout the year/semester, students will have the opportunity to secure an internship with a local business aligned with their career aspirations. The course is structured to blend classroom learning with on-the-job experiences, fostering a dynamic and interactive environment. Students have interned in areas such as: law enforcement, education, physical therapy, banking, real estate, business, veterinary science, art, fashion, and more!

## College Personal Finance



**Credit:** .5  
**Level:** 10, 11, 12

**Fees:** If taken for college credit, approximately \$315 for 3 college credits. College credit is available through UW-Oshkosh Cooperative

**Note:** This course fulfills the Financial Literacy graduation requirement.

Welcome to College Personal Finance, a dynamic course designed to empower you with essential skills for navigating the complexities of personal finance. Tailored for college students, this interactive curriculum goes beyond the basics, covering budgeting, credit management, understanding credit cards, and mastering checking and savings accounts. Through real-life case studies and hands-on exercises, you'll gain the knowledge and confidence needed to make informed financial choices.

But that's not all—this course takes a holistic approach to personal finance. Explore the intricacies of saving and investing, participate in a stock market simulation, and delve into critical decisions like buying versus leasing a car and renting versus buying a home. Embrace a comprehensive understanding of these major financial choices and learn how to make strategic decisions that align with your goals. This course isn't just about numbers; it's your roadmap to financial empowerment and a brighter future. Join us on this transformative journey, where you'll not only gain financial knowledge but also develop the skills to navigate your financial landscape with resilience and intelligence

## Computer Apps for College & Careers



**Credit:** .5  
**Level:** 9, 10, 11, 12  
**MATC Transcribed Course** COMPSW-106  
**(3 credits)**

Computer Applications is a computer literacy course in which you will become skilled in Microsoft Office software applications for college, career, and personal applications. Multidisciplinary projects will involve using Word, Excel, Access, PowerPoint and Publisher. You will have the opportunity to become industry certified in the MS Office applications. These certifications will give you added value for college and future work.

## Desktop Publishing

**Credit:** .5  
**Level:** 9, 10, 11, 12  
**MATC Transcribed Course** GRDS-110  
**(3 credits)**

Welcome to the Desktop Publishing course, where creativity meets functionality! This hands-on journey utilizes Adobe InDesign software to empower students in crafting a diverse array of print and digital media, from captivating business cards and dynamic sports team calendars to personalized calendars, menu redesigns, eye-catching wall graphics, and beyond. The focus is on practical application, ensuring students not only understand design principles but also gain proficiency in Adobe InDesign, a vital tool in the world of desktop publishing.

Whether you aspire to a career in graphic design or aim to enhance your visual communication skills, this course is tailored to your goals. Immerse yourself in the intersection of business, graphic design, and technology, and let your creativity flourish as you build a portfolio of stunning designs. In Desktop Publishing, you'll acquire the knowledge and skills to thrive in the dynamic landscape of visual communication, creating print and digital masterpieces that leave a lasting impression.

## Digital Video Design



**Credit:** 1  
**Level:** 9, 10, 11, 12

Embark on a cinematic journey with our Digital Video Design course, where creativity meets technology. This class is an immersive exploration of digital video creation using industry-standard tools, primarily Adobe Premiere. Students will master the art of capturing and editing video, gaining hands-on experience with an array of cutting-edge technologies, including drones, cranes, sliders, and more. From crafting compelling movie trailers and TV pilots to producing engaging infomercials, music videos, and more, students will have the opportunity to bring their creative visions to life through diverse and dynamic projects.

## Game and Mobile App Design

**Credit:** .5

**Level:** 9, 10, 11, 12

Game and Mobile App Design is an introductory course to coding and app development that will engage you in project-based learning. You will build your games in Construct and publish to a variety of platforms like Android, iOS, Windows, Mac, and the Web. Mobile apps will be built using App Inventor, a cloud-based tool, on an Android platform which is used in smartphones, tablets, and other personal electronics.

## Personal Finance

**Credit:** .5

**Level:** 10, 11, 12

**Note:** *This course fulfills the Financial Literacy graduation requirement.*

**Math Credit:** This course may be used as .5 math credit for graduation

Personal Finance will provide fundamental coverage in money management (paychecks, taxes, and checking accounts), financial security (savings accounts, stocks, bonds, and mutual funds), credit management, and risk management (personal risk and auto, home, and health insurance).

## Sports & Entertainment Management

**Credit:** .5

**Level:** 10, 11, 12

This course is for students interested in learning how the sports and entertainment industries implement management and marketing strategies to promote, sponsor, and operate events. Topics covered will include sponsorship development, event management, licensing and merchandising, promotion, endorsements, in-game promotions, and ticket sales. Classroom projects, guest speakers, and a VIP experience with a professional sports team (i.e. Green Bay Packers, Milwaukee Bucks, etc.) will be included.

## Web Design

**Credit:** .5

**Level:** 9, 10, 11, 12

In Web Design, you will learn how to create a well designed website that is easy to navigate, and uses appropriate SEO (Search Engine Optimization). Students will take part in the design and maintenance of the Hawks' Nest (School Store) website. A variety of online programs will be utilized to help maintain and manage web pages.





# COMMUNICATION ARTS

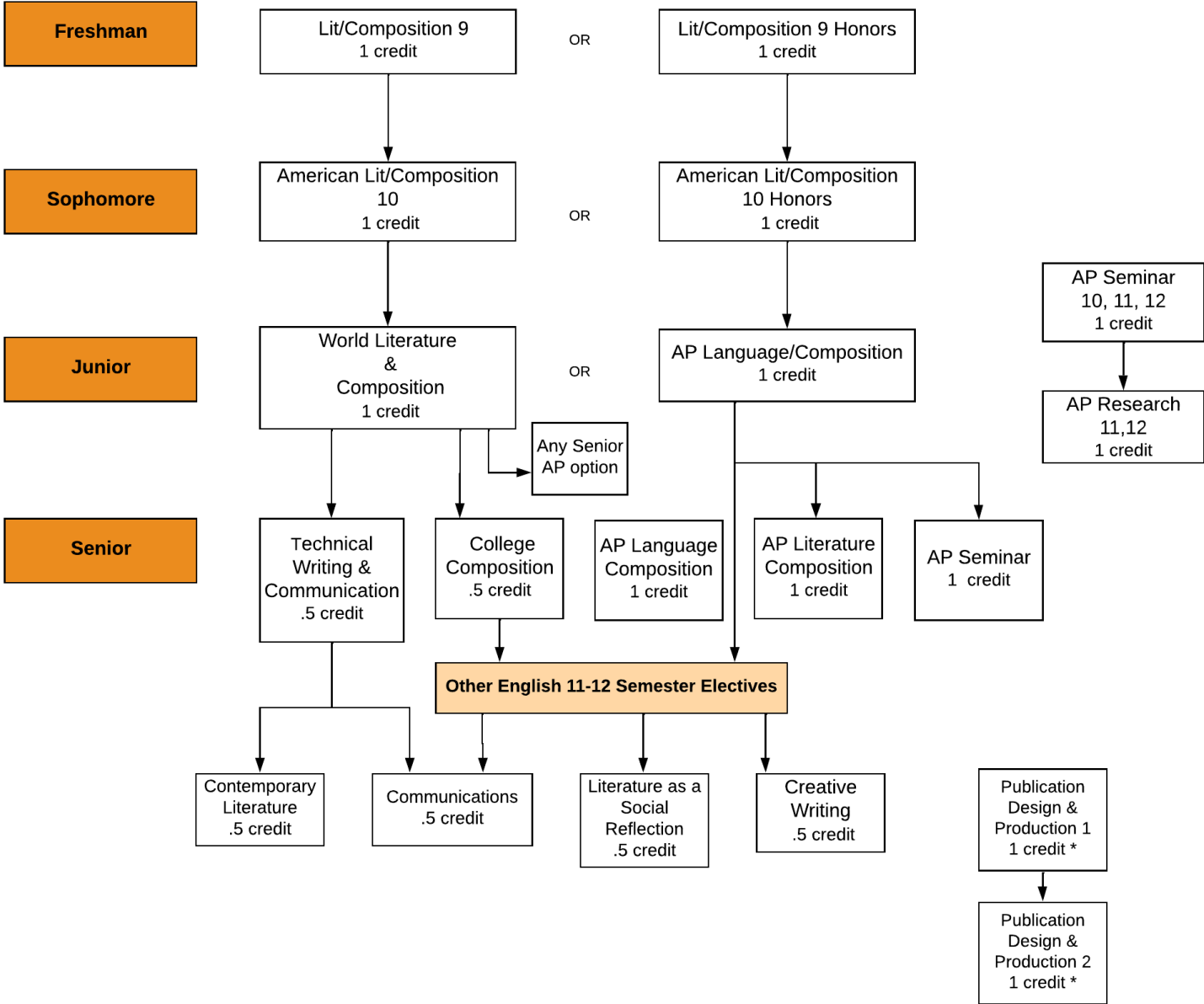

\* Does not count toward Communication Arts graduation requirement.

## **Literature & Composition 9**

**Credit: 1**

**Level: 9**

**Prerequisite: none**

Freshmen in Literature and Composition 9 will use fiction, nonfiction, poetry, and drama as vehicles for developing critical reading and literacy skills. Students will improve their language and writing skills, analytical abilities, and creative capacity while writing paragraphs and expository essays, conducting research, and presenting oral projects based on the study of literature. Course goals are to increase students' ability to appreciate and understand the major genres of literature; to study various literary techniques, vocabulary, and characteristics of the major genres; to practice group discussion and oral presentation techniques; to continue to refine their craft of writing; to introduce necessary research skills.

## **Literature & Composition 9 Honors**

**Credit: 1**

**Level: 9**

**Prerequisite: teacher recommendation**

A student in Literature and Composition 9 Honors will explore the Literature and Composition 9 curriculum in greater depth and, in some cases, at a faster pace. A learner in the Honors course thinks critically and creatively, completes tasks independently, produces quality work consistently and in a timely manner, and demonstrates a command of English literacy skills. In addition to the skills practiced in Literature and Composition 9, the Honors course emphasizes literary analysis, logic and reasoning, argumentation, on-demand writing, and discussion. Honors level students enter freshman year having displayed strong reading, writing, and analytical skills.

## **American Literature & Composition**

**Credit: 1**

**Level: 10**

American Literature continues to develop a student's critical and creative thinking skills through reading, writing and speaking. Students will read novels, drama, poetry and non-fiction texts with focus on Native Americans, Puritans, Transcendentalists, the Jazz Age, the Harlem Renaissance, and modern literature. Major assessments include a research essay, literary analysis, on-demand writing and presentations.

## **American Literature & Composition Honors**

**Credit: 1**

**Level: 10**

**Prerequisite: teacher recommendation**

American Literature Honors is designed for students who have displayed strong reading, writing and critical thinking skills. Students will read novels, drama, poetry and non-fiction texts with focus on Native Americans, Puritans, Transcendentalists, the Jazz Age, the Harlem Renaissance, and modern literature. Major assessments include research essay, literary analysis, on-demand writing and presentations. Students in Honors will also take part in a semester-long project based learning Justice Project.

## **World Literature & Composition**

**Credit: 1**

**Level: 11**

World Literature & Composition is a survey course for juniors to explore their individual relationship to culture and human civilization through the study of ancient, classic, and modern texts. While embarking on a heroic journey through the historical and social influences of cultures throughout the world, students will think critically about literary techniques, perspectives, and major themes of the shared human experience. Students will continue to reinforce previously learned grammar, composition, oral communication, and research skills.

## **AP Language and Composition**

**Credit: 1**

**Level: 11, 12**

**Prerequisite: teacher recommendation**

**Fee: \$97 for the AP Exam (optional)**

This is a college level course. This class is designed to meet the intellectual challenges and workload consistent with the possible curriculums described in entry-level courses in universities and colleges. The course focuses on rhetorical analysis of non-fiction texts and the development and revision of well-reasoned, evidence-centered analytic and argumentative writing. This course directly prepares those students who choose to take an Advanced Placement Test of Language and Composition at the end of the year.

## **AP Literature and Composition**

**Credit: 1**

**Level: 12**

**Prerequisite: teacher recommendation**

**Fee: \$97 for the AP Exam (optional)**

This is a college level course. This class is designed to meet the intellectual challenges and workload consistent with the possible curriculums described as "Freshman English" in universities and colleges. Students will read and analyze, in discussion and writing, poetry, short story, drama, and the novel. Students will study arguments, including logic and rhetoric. This course directly prepares those students who choose to take an Advanced Placement Test of Literature and Composition at the end of the year.

## **AP Seminar Credit: 1**

**Level: 10, 11, 12**

**Prerequisite: Previous or concurrent enrollment in an AP course is recommended**

**Fee: \$145 for the AP Exam**

**Note:** *This course can count toward the senior English requirement if taken senior year*

The AP Seminar course is an inquiry-based course that aims to engage students in cross-curricular conversations that explore real-world topics and issues from multiple lenses and perspectives. Students are empowered to collect and analyze information with accuracy and precision in order to craft and communicate evidence-based arguments, both written and orally. The skills practiced and refined in this class are required in the AP Research course, the second course in the AP Capstone program. [AP Capstone Info](#). Benefits of [AP Capstone](#) program.

## AP Research

**Credit: 1**

**Level: 11, 12**

**Prerequisite: AP Seminar. (AP Seminar is a prerequisite for AP Research. Completing AP Seminar and all its required assessment components is necessary for students to develop the skills to be successful in AP Research.)**

**Fee: \$145 for the AP Exam**

AP Research, the second course in the AP Capstone experience, allows students to deeply explore an academic topic, problem, issue, or idea of individual interest. Students design, plan, and implement a yearlong investigation to address a research question. Through this inquiry, they further the skills they acquired in the AP Seminar course by learning research methodology, employing ethical research practices, and accessing, analyzing, and synthesizing information. Students reflect on their skill development, document their processes, and curate the artifacts of their scholarly work through a process and reflection portfolio. The course culminates in an academic paper of 4,000–5,000 words (accompanied by a performance, exhibit, or product where applicable) and a presentation with an oral defense. Find out the benefits of [AP Capstone](#).

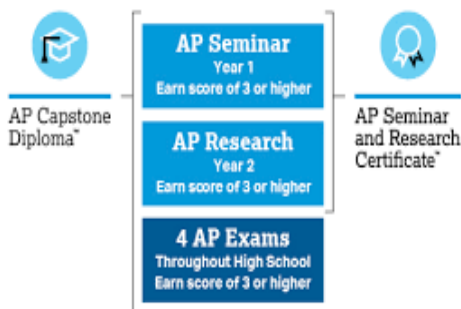

## Contemporary Literature

**Credit: .5**

**Level: 11, 12**

**Prerequisite: World Literature & Composition**

Contemporary Literature focuses on internal conflict and the search for an identity, in a complex, changing society. Students will review trends in modern literature and acquaint themselves with the different forms of media used to translate those forms into everyday experiences.

## Communications

**Credit: .5**

**Level: 11, 12**

Students will engage in speaking and listening activities: intrapersonal, interpersonal, group, and public communication. Throughout the course, students will practice listening and speaking, as well as conversational and advanced questioning skills through games and activities designed to strengthen confidence and understanding. The course is designed to be a practical approach to learning a wide range of skills that will be needed for a university/work environment. By the end of the semester, students will have created tangible products that prove mastery over a range of professional communication skills.

[Table of Contents](#)

## Creative Writing

**Credit: .5**

**Level: 11, 12**

Within a performance-based and workshop setting, students will generate various types of artistic writing including poetry, the short story, the screenplay, sensory writing, nonfiction, and a variety of pieces expressing voice. Students will critique others' writing and share their own. From the critiques, students will refine their individual pieces of writing for a performance-based semester portfolio. Throughout the course, they will develop and/or improve artistic writing skills and integrate all facets of language arts: listening, speaking, reading, and writing.

## College Composition

**Credit: .5**

**Level: 12**

**Prerequisite: World Literature & Composition (can not take if had AP Language & Composition)**

Emphasis will be on expository writing, using critical thinking skills in paragraph and essay writing. Students will be challenged to demonstrate writing skills using more complex content material and sophisticated writing styles in order to refine the forms of expository expression.

## Literature As A Social Reflection

**Credit: .5**

**Level: 11, 12**

**Prerequisite: World Literature & Composition or AP Language**

Both historically and today, authors and filmmakers use their literary or cinematic works (novels, plays, poems, documentaries, films, etc.) to reflect the world around them and comment on, critique, or expose the issues facing society. Through a variety of challenging texts, this course explores social issues such as race, gender, and equity. Performance-based class discussions, group projects, and presentations are the foundation for student learning and assessment. Along with exploring texts together as a class or in a group, students will also develop an independent project expressing their own social reflection, to be presented during the final exam period. Ultimately, students will continue to build on literary analysis, writing, and discussion skills introduced in previous classes while exploring issues in modern literature.

## Publication Design & Production 1

**Credit: 1**

**Level: 10, 11, 12**

**Note: Not approved by the NCAA.**

***This is an elective class which does not count toward the graduation English requirement.***

The course focuses on the development of published, nonfiction journalistic works for the yearbook and other school and community publications. This includes writing, interviewing, researching, editing and revising skills in workshop format. In addition, students will study design and photography principles while learning Adobe CS as extensions of their written work. Students will also write, produce, edit and publish video announcements in teams throughout the year using professional video equipment and Final Cut Pro.

## **Publication & Production 2**

**Credit: 1**

**Level: 11, 12**

**Prerequisite: Publication Design & Production 1**

**Note: Not approved by the NCAA**

***This is an elective class which does not count toward the graduation English requirement.***

This course is taken by students who have already completed a year of Professional Writing. The course focuses on the advanced development of published, nonfiction journalistic works for the yearbook and other school and community publications. This includes writing, interviewing, researching, editing and revising skills in workshop format. In addition, students will study design and photography principles while learning Adobe CS as extensions of their written work. Students will also write, produce, edit and publish video announcements in teams throughout the year using professional video equipment and Final Cut Pro.

## **Technical Writing & Communication**

**Credit: .5**

**Level: 12**

**Prerequisite: World Literature & Composition**

**Note: Not approved by the NCAA**

This course focused on real life, practical writing and communication skills. Projects/assignments include: group discussion, research, both oral and written reports on research, task analysis and demonstration, analysis of technical articles and work-related materials, business letters, resumes, and job applications. Students will reinforce reading, writing, research, and critical thinking skills taught during the first three years of high school

# COMPUTER SCIENCE

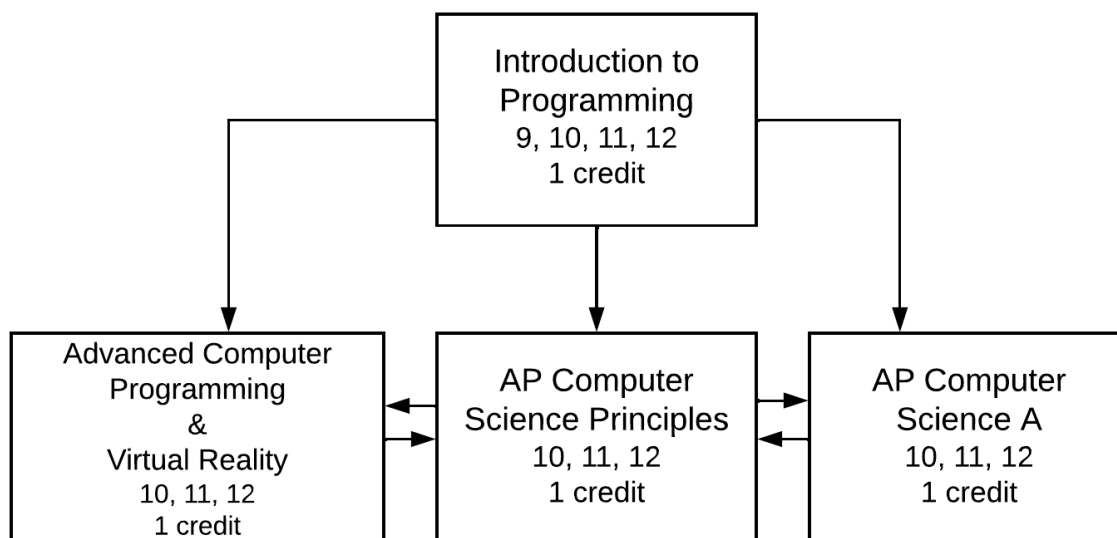

## Introduction to Programming

**Credit: 1**

**Level: 9, 10, 11, 12**

**Prerequisite: B or higher in Algebra or Math 8. Math Skills will be used throughout this course.**

**Math Credit:** *This course may be used as the 3<sup>rd</sup> math credit for graduation but most colleges won't recognize it as a math credit.*

The focus of this course is to introduce computer programming using the language of Visual Basic. Major topics covered are: Graphical User Interface, Event Driven Programming, Variables, Formatting, Selection Statements, Functions, Loops, String Manipulation, Arrays, RAM, ROM, CPU, and Saving and Opening Sequential Files.

## Advanced Computer Programming & Virtual Reality

**Credit: 1**

**Level: 10, 11, 12**

**Prerequisite: Introduction to Programming or Teacher Approval**

During the first semester students will learn how to program using the language C++. The following topics will be covered: history of computers, variable types, selection structures, loops, functions, arrays, and object oriented programming. By the end of the first semester, students will have created multiple C++ applications. During the second semester, students will learn about the principles of VR technology, including optics, displays, stereopsis, and tracking. By the end of the course, students will have created and deployed a comfortable, high performance VR application using Unity. Not recommended to take concurrently with AP CSA.

## AP Computer Science Principles

**Credit: 1**

**Level: 10, 11, 12**

**Prerequisite: Introduction to Programming or Teacher Approval**

**Fees: AP practice book and \$98 for the AP Exam (optional)**

AP Computer Science Principles introduces students to the foundational concepts of computer science and challenges them to explore how computing and technology can impact the world. There are 5 big ideas in the course framework: Creativity Development, Data, Algorithms and Programming, Computer Systems and Networks, Impact of Computing. Students will use computation tools to analyze and study large data sets, develop effective communication and collaboration skills, be a well-educated citizen who understands how computer science impacts people and society, and design creative artifacts with practical, personal or societal intent.

## AP Computer Science A

**Credit: 1**

**Level: 10, 11, 12**

**Prerequisite: Introduction to Programming or Teacher Approval**

**Fees: AP practice book and \$98 for the AP Exam (optional)**

AP Computer Science A introduces students to the computer programming language of JAVA. The topics covered include primitive types, using objects, boolean expressions and if statements, iteration, writing classes, arrays, array lists, 2D arrays, inheritance, recursion and larger scale programs recommended from the College Board (AP). Students will analyze code to find mistakes and output, think creatively to solve real world applications, and construct algorithms to solve a problem. Not recommended to take concurrently with Advanced Programming and Virtual Reality.

# FAMILY AND CONSUMER SCIENCE

## Culinary

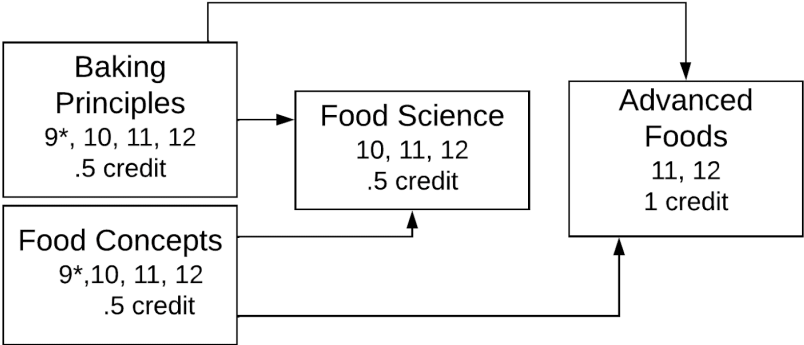

## Child Development

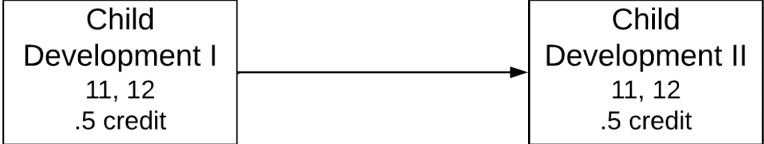

## Fashion/Sewing

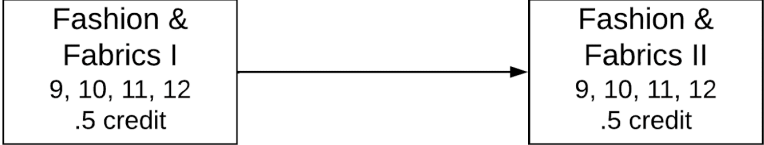

## Other FCS Courses

**Intro to Health Occupations**  
10, 11, 12  
.5 credit

**Housing & Interior Design**  
10, 11, 12  
.5 credit

**Independent Living**  
11, 12  
.5 credit

\*Food Concepts-Prerequisite for 9th grade only-completion of Baking Principles before taking Food Concepts.

Advanced Foods students will receive ServSafe certification and two transcribed credits from MATC.

Food Science counts toward the 3 credits of Science required for graduation (may not count toward college admissions requirements).



## **Advanced Foods & Restaurant**

### **Management**

**Credit:** 1

**Level:** 11, 12

**Prerequisite:** Food Concepts and Baking Principles earning a C or better in each course.

**Fees:** \$35.00 (includes ServSafe Certification test)

**MATC transcribed course CULMGT-112**  
**(2 credits)**

This course will equip students with the advanced skills necessary to enter the food service industry. Students will learn about food service operations including health and safety, workstations, plating and design, and many other roles of the professional chef. Successful chefs must be able to do more than simply prepare delicious recipes; they need to be able to determine costs, manage resources. At the start of the course, students will work on skills necessary to take the ServSafe Food Handler online certification exam. Students who pass the exam will also receive advanced standing from MATC and will be exempt from taking the MATC Food Service Sanitation course. Students will have the opportunity to participate in culinary competitions. The course will include implementing a carry out restaurant for GHS staff while using cost analysis /profit data.

### **Baking Principles**

**Credit:** .5

**Level:** 9, 10, 11, 12

**Fees:** \$25.00

This course will consist of basic baking fundamentals. The study of how ingredients work together and the ratios will give anyone the freedom of developing their own creative recipes. Preparation of food will include: quick breads, pies, yeast breads, cookies and desserts. This course will also concentrate on safety techniques, precise measurement, standardized recipes and formulas. The goal is also to introduce food service and food service careers together with fostering creativity in food preparation.

### **Food Concepts**

**Credit:** .5

**Level:** 9, 10, 11, 12

**Fees:** \$25.00

**Prerequisite:** Baking Principles if taking second semester in 9th grade.

Students will be introduced to basic cooking techniques used in the preparation of food. Cooking labs involve the organization, preparation, tasting, and evaluation of food created by the students. Safety and sanitation, basic measurement skills, nutrition and the principles of food preparation are incorporated into each unit. Units include: Grains, Eggs and Dairy, Soups and Sauces, Meat and Poultry.

## **Food Science**

**Credit:** .5

**Level:** 10, 11, 12

**Prerequisite:** Food Concepts or Baking Principles (formerly Culinary Arts). Must have either course prior to taking Food Science.

**Fees:** \$25.00

**Note:** *This course may be used as a .5 credit of science for graduation but most colleges won't recognize it as a science credit.*

Food science benefits consumers every day with healthier diets, better tasting affordable foods, and increased food safety. Food Science is an exciting area that applies a blend of basic sciences such as biology, chemistry and physics with biochemistry and mathematics to improve the taste, nutrition and value of the world's food supply. The curriculum includes food science experiments using the scientific method. Units include sensory evaluation, lipids, simple and complex carbohydrates, food additives and analogs, proteins, and enzymes.

### **Child Development 1**

**Credit:** .5

**Level:** 11, 12

**MATC transcribed course CHILDD-148**

**(3 credits)**

Students will learn about characteristics needed to be a successful child care provider, child care programs and childcare careers. This course provides students with an understanding of the physical, cognitive, social and emotional development of children from birth to age 5. The students will learn teaching methods and guidance strategies to prepare lessons that will be taught to preschoolers. A lab experience in the form of a preschool that is run by the students is the culminating activity. This will provide an opportunity for the students to plan and implement themed lessons. The goal is for students to gain knowledge of children through teaching and observation of developmental milestones and provide insight and opportunity for students interested in child-related careers or their own future parenting roles.

### **Child Development 2**

**Credit:** .5

**Level:** 11, 12

**Prerequisite:** Child Development 1

**MATC transcribed course CHILDD-178**

**(3 credits)**

Students will continue their study and observations of children. This will take place in the form of a preschool that is run by the students. The focus on lesson planning will be in the following areas: literacy, science, math, social studies, art, and music. Other areas of study will include health and safety of children, parenting skills, special needs children and the vast area of careers open to those who wish to work with or for children. After successful completion of Child Development II, students will have a grasp of what occurs in the professional Child Care setting.

## **Introductions to Health Occupations**

**Credit: .5**

**Level: 10, 11, 12**

This course will provide an orientation to the healthcare field. Areas of study include the history and trends of the healthcare field, legal and ethical responsibilities, personal and professional qualities of a healthcare worker, medical terminology, cultural diversity, geriatric care and employability skills. A blend of guest speakers, field trips and opportunities for job shadowing will provide a well-rounded view of the healthcare field.

## **Fashion and Fabrics 1**

**Credit: .5**

**Level: 9, 10, 11, 12**

**Fees: \$10.00 for supplies. Additional costs depending on projects chosen**

Fashion and Fabrics I is a beginning level class designed for students who have an interest in learning how to sew. Students will learn how to use a sewing machine, construction principles, reading patterns and follow directions to create a variety of projects. The students will also explore the world of fashion.

## **Fashion and Fabrics 2**

**Credit: .5**

**Level: 9, 10, 11, 12**

**Prerequisite: Fashion and Fabrics 1**

**Fees: \$10.00. Additional costs depending on projects chosen**

This class is a continuation of Fashion and Fabrics I. This course is designed for students who wish to expand their skills in sewing construction. The students will be using commercial patterns to create projects. The projects created will be based on the individual skill level of the students.

## **Housing and Interior Design**

**Credit: .5**

**Level: 10, 11, 12**

Students will learn about the elements and principles of design, the role of color, recognizing furniture styles and selecting furniture. Students will develop a design plan for a fictitious client using presentation boards, samples and scale drawings. Elements of style, color scheme, space plan, backgrounds and furniture placement are considered for their client. This is a project based class that uses a variety of activities that foster learning. Careers in interior design and related occupations are also explored.

## **Independent Living**

**Credit: .5**

**Level: 11, 12**

**Note: This course fulfills the Financial Literacy graduation requirement**

A comprehensive course designed to help students explore many aspects of being a responsible adult. Students will learn about personal development, decision-making, communication, conflict resolution, careers and financial literacy. There is an emphasis on budgeting and managing finances, investing, and insurance. The course prepares students for future life responsibilities.





# MATHEMATICS

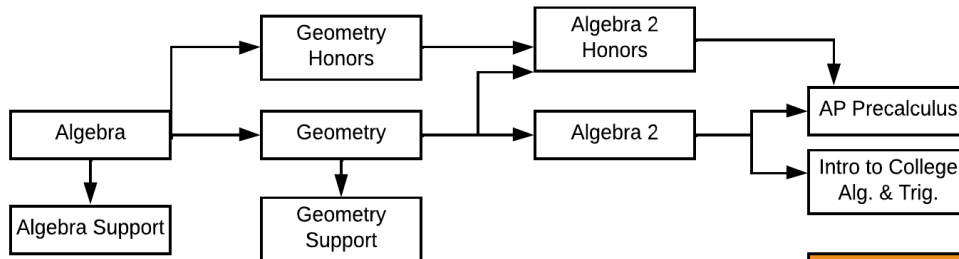
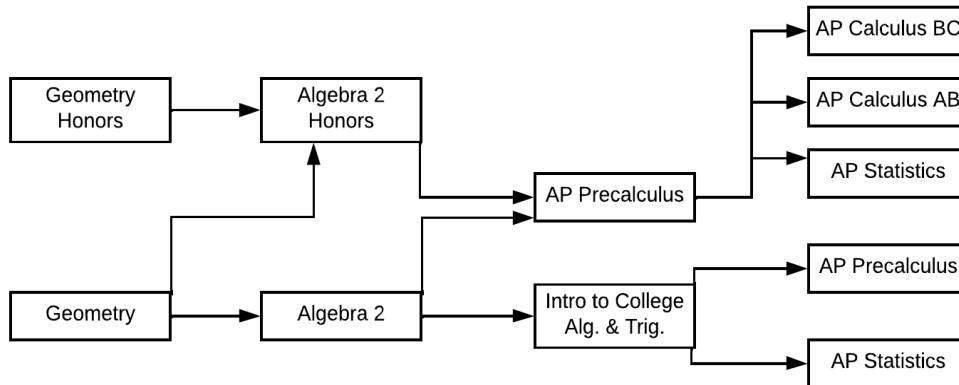
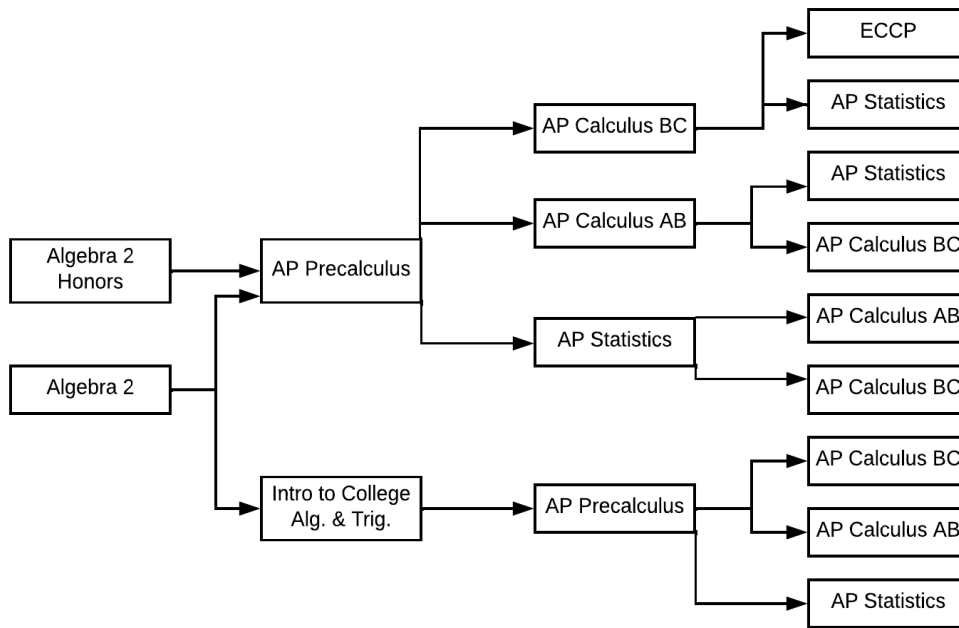

**The following courses will meet GHS math graduation requirements (not college admissions requirements)**  
 1. Accounting  
 2. Personal Finance  
 3. Intro to Programming

## **Algebra**

**Credit: 1**

**Level: 9, 10, 11, 12**

**Graphing calculator: TI-83 or TI-84**

Algebra is the foundation for all upper level mathematics. The purpose of this course is to provide students with a basis for advanced mathematics and aid them in solving mathematical problems. Basic algebraic properties are developed in which the student solves equations, manipulates formulas, and learns graphing techniques. Numerous efforts are made to show meaningful relationships to the areas of science, technology, and other math related areas.

## **Algebra Support**

**Credit: .5 per semester**

**Level: 9**

**Prerequisite: Test score performance and recommendation of 8th grade teacher. This course does not count toward the math graduation requirement.**

**Graphing calculator: TI-83 or TI-84**

Algebra Support is a course taken concurrently with an Algebra class. Students review and work on prerequisite math skills while also exploring/reinforcing algebra concepts in greater depth than a typical Algebra class would allow.

## **Algebra 2**

**Credit: 1**

**Level: 9, 10, 11, 12**

**Prerequisite: completion of Algebra**

**Graphing calculator: TI-83 or TI-84**

This course begins with a review of linear equations (solving and graphing) and then transitions to higher degree equations such as parabolas and hyperbolas. This course begins a transition to higher level math courses and introduces using a graphic calculator. Topics covered include: Polynomial and Rational Functions, Complex Numbers, Rational Exponents, transformation of Functions, Sequences and Trigonometric Functions. This course allows the student to broaden algebraic principles developed in Algebra and prepares the student for advanced and college preparatory classes.

## **Algebra 2 Honors**

**Credit: 1**

**Level: 9, 10, 11, 12**

**Prerequisite: Algebra and Geometry or Geometry Honors**

**Graphing calculator: TI-83 or TI-84**

Algebra 2 Honors is an accelerated version of Algebra 2. The greater depth, breadth and rigor of the course is intended to prepare students for success in future math courses including AP Calculus and/or AP Statistics. The course is designed for students who are ready to accept the challenge of studying advanced topics from Algebra and Trigonometry. The use of technology is an important feature of this course.

## **AP Calculus AB**

**Credit: 1**

**Level: 11, 12**

**Prerequisite: Satisfactory completion of Pre-Calculus and consent of previous instructor.**

**Fees: \$25.00 and \$97 for the AP Exam (optional)**

**Graphing calculator: TI-83 or TI-84**

AP Calculus AB is designed to be the equivalent of a first semester college calculus course devoted to topics in differential and integral calculus. This course features a multi representational approach to calculus with concepts, results and problems expressed graphically, numerically, analytically, and verbally. Students work throughout the year to be prepared to successfully complete the AP Exam in May.

## **AP Calculus BC**

**Credit: 1**

**Level: 11, 12**

**Prerequisite: Satisfactory completion of Pre-Calculus or AP Calculus (AB) and consent of previous instructor**

**Fees: \$25.00 and \$97 for the AP Exam (optional)**

**Graphing calculator: TI-83 or TI-84**

Units covered include a complete review of material taught in the AP Calculus (AB) course, an introduction to the basic concepts of series, sequences, parametric, vector, and polar functions. The course emphasizes a multi-representational approach to calculus, with concepts, results, and problems being expressed geometrically, numerically, analytically, and verbally. AP Calculus (BC) is concerned with continuing the students' understanding of the concepts of calculus and providing experience with its methods and applications.

## **AP Precalculus**

**Credit: 1**

**Level: 10, 11, 12**

**Prerequisite: Completion of Algebra 2 and consent of previous instructor**

**Graphing calculator: TI-83 or TI-84**

**Fee: \$98 for the AP Exam (optional)**

AP Precalculus is designed to be the equivalent of a first semester college precalculus course. AP Precalculus provides students with an understanding of the concepts of college algebra, trigonometry, and additional topics that prepare students for further college level mathematics courses. This course explores a variety of function types and their applications—polynomial, rational, exponential, logarithmic, trigonometric, polar, parametric, vector-valued, implicitly defined, and linear transformation functions using matrices. Throughout the course, the mathematical practices of procedural and symbolic fluency, multiple representations, and communication and reasoning are developed. Students experience the concepts and skills related to each function type through the lenses of modeling and covariation and engage each function type through their graphical, numerical, analytical, and verbal representations.

## **AP Statistics**

**Credit: 1**

**Level: 11, 12**

**Prerequisite: completion of Pre-Calculus and consent of previous instructor**

**Fee: \$97 for the AP Exam (optional)**

**Graphing calculator: TI-83 or TI-84**

This class is highly recommended for college-bound students planning to enter into the health science, social science or business fields. The course covers the language and methods of probability and statistics in the areas of sociology, business, ecology, economics, education, medicine, psychology and mathematics. Several different methods for describing sample data are presented. Measures of central tendency and variation are included. Rules of probability and probability distributions lead into the normal distribution and properties of the normal curve. Sampling techniques, which include simulation and experiment design, and hypothesis testing are stressed in the second half of the course. Students are exposed to many different methods for analyzing data for causation and strength of relationship between two variables.

## **Geometry**

**Credit: 1**

**Level: 9, 10, 11, 12**

**Prerequisite: completion of Algebra.**

**Ruler and protractor, Graphing calculator: TI-83 or TI-84**

Geometry deals with an in-depth understanding of shapes, reading and writing proofs, and the applications and use for postulates and theorems. Items we will focus on are: unique properties of specific shapes in 2D and 3D; lines, planes, angles, congruency, and similarity; writing and understanding proofs; perimeter, area, surface area and volume.

## **Geometry Honors**

**Credit: 1**

**Level: 9, 10, 11, 12**

**Prerequisite: Completion of Algebra with a grade of A or B along with relevant scores on the 8th grade MAPS and Forward tests.**

**Ruler and protractor, Graphing calculator: TI-83 or TI-84**

Geometry Honors is an accelerated version of Geometry. The greater depth, breadth and rigor of the course is intended to prepare students for success in future math courses and eventually AP Calculus and AP Statistics. The course is designed for students with a strong mathematics background and who have a willingness to work hard and be ready to accept a challenge.

## **Geometry Support**

**Credit: .5 per semester**

**Level: 10, 11, 12**

**Prerequisite: Algebra Teacher recommendation. This course does not count toward the math graduation requirement.**

**Ruler and protractor, Graphing calculator: TI-83 or TI-84**

Geometry Support is a course that will be taken concurrently with a Geometry class. Students will work on prerequisite basic math skills, as determined by the teacher of the Geometry class. Students will be exploring and reinforcing Algebra concepts that are identified as necessary in the Geometry curriculum.

## **Intro to College Algebra & Trigonometry**

**Credit: 1**

**Level: 11, 12**

**Prerequisite: Completion of Algebra 2 and consent of previous instructor.**

**Graphing calculator: TI-83 or TI-84**

The purpose of this course is to provide students with a strong mathematical foundation in preparation for college or upper level high school mathematics. It is primarily intended to be a 4<sup>th</sup> year math class. The first part of this course will cover functions and their graphs: polynomial, rational, logarithmic, and exponential. The second phase will focus on Trigonometry/Analytic Geometry: right triangle properties, trigonometric functions and graphs, inverse trig functions, conics and polar equations.

# MUSIC

## Concert Band

**Credit: 1.0**

**Level: 9, 10, 11, 12**

**Prerequisite: None**

The GHS Concert Band is open to all band students. This ensemble is the entry level consisting of freshmen and sophomores. This course begins the high school level of musicianship and lays the foundation necessary for success in upper division ensembles. Emphasis is placed on student engagement and on solid fundamentals for instrumental techniques. This is done through rigorous and challenging repertoire for the age and technical abilities of ensemble members. Membership in Concert Band is by default should a student decide not to audition into upper division ensembles, but it is important to note that grade level bears no factor in determining enrollment in any ensemble. Skill level and work ethic are the determining factors in the audition process. Music performed in Concert Band is typically of a 2.5 to 3.5 difficulty or "Easy" to "Medium-Easy." All students enrolled in any band at GHS are required to march as a member of GHS Marching Black Hawks. Our impressive marching ensemble performs a halftime field show at all home football games and marches in various parades in our school and community. Students will also take part in the GHS Pep Band which performs at all home football game and a selection of home basketball games.

## Wind Ensemble

**Credit: 1**

**Level: 10, 11, 12**

**Prerequisite: Audition/Consultation with Director**

The GHS Wind Ensemble is the most advanced ensemble offered at Grafton High School. Enrollment in Wind Ensemble is earned through audition or in some cases, a consultation with the director. It is important to note that grade level has no factor in your enrollment in any ensemble at GHS. Concert Band is mostly underclassmen and Wind Ensemble is mostly upperclassmen but there are always a few students that

cross over for various reasons. Skill level and work ethic are the primary factors in determining your enrollment in an ensemble at GHS. Scheduling should not hinder your ability to be in band so please speak with the director if you have a conflict. Compared to Concert Band, there are some additional opportunities for performance that include, unique performances at other GSD schools or the community and clinics among others.

Music performed in Wind Ensemble will largely lie around the Grade 3.5-5.5 range or Medium to advanced. All students enrolled in any band at GHS are required to march as a member of the GHS Marching Black Hawks. The Marching Black Hawks perform a field show during halftime of the homecoming game (and possible other home games) as well as a few parades in the community. Students will also take part in the GHS Pep Band which performs at all home football games and a selection of home basketball games.

## Jazz Ensemble

**Credit: 0.5**

**Level: 9, 10, 11, 12**

**Prerequisite: Audition and/or Instructor Consent**

Jazz Ensemble provides instruction and development in the musical genre of jazz which may include, but is not limited to, the study of: the blues, salsa, mambo, tango, bossa nova, bebop, hard bop, rhythm and blues, funk, funk-rock, the shuffle, big band dance, ballads, and swing. This ensemble is open to 9-12 students by audition and/or instructor consultation and consent and meets OUTSIDE of the academic school day. Rehearsals may take before or after school with occasional weekend commitments as performances draw nearer. Students should expect an opportunity to study and perform high quality jazz ensemble literature and to learn basic skills involving improvisation within the jazz idiom. Emphasis is placed on the widely accepted basics of swung eighth notes and jazz articulations through the study of etude books and technical method books as well as charts for jazz ensemble. Jazz Ensemble performs in community events, concerts, and at jazz festivals across Wisconsin and the Midwest. Those in this ensemble or who plan to be are strongly encouraged to audition for the WSMA State Honors Jazz Ensemble. Instrumentation: For winds and rhythm section, a traditional big band instrumentation is sought after as outlined below. Exceptions to this philosophy are at the discretion of the director. Prior enrollment in any jazz ensemble does not guarantee enrollment.

Alto Saxophone – 2	Piano – 1/2
Tenor Saxophone – 2	Piano Guitar – 1
Baritone Saxophone – 1	Electric Bass – 1
Trombone – ½	Drum Set – 1/2
Trumpet – ½	Auxiliary Percussion & Vibraphone – 1

Non-Traditional Instruments: Flutes, Clarinets, Euphoniums, French Horns, etc. are accepted at the discretion of the director.

## Camerata

**Credit: 1**

**Level: 10, 11, 12**

**Prerequisite: Audition**

Camerata is an auditioned, women's, intermediate ensemble. This ensemble is ideal for students who have mixed choral ensemble experience and want to pursue single-gender choral studies. Students will learn about women's ensemble repertoire as well as the differences from mixed to single-gender singing through performance. The course includes topics such as vocal pedagogy techniques, sight reading, basic music theory, and a wide array of cultural and historical perspectives through repertoire selection for female voices. Reflection, analysis, and excellence are the pillars of the course. Participation in WSMA Solo and Ensemble Festivals is optional, but highly encouraged. Placement in Camerata is by audition only. It is important to note that grade level bears no factor in determining enrollment in any ensemble at GHS. Skill level and work ethic are the determining factors in the audition process.

## **Concert Choir**

**Credit: 1**

**Level: 10, 11, 12**

**Prerequisite: Audition**

Concert Choir is an auditioned, open mixed, and advanced level choral ensemble. This ensemble is ideal for students who have a minimum of one year experience in a high school entry level ensemble. Students will learn about advanced choral repertoire and skills through performance. The course includes topics such as vocal pedagogy techniques, sight reading, music theory, chamber music, basic conducting opportunities, and a wide array of cultural and historical perspectives through repertoire selection. Reflection, analysis, and excellence are the pillars of the course. Participation in WSMA Solo and Ensemble Festivals is optional, but highly encouraged. Those choosing not to participate will go through the process of preparing for the Solo and Ensemble Festival and then perform works for the class or in another manner at the discretion of the instructor. Placement in Concert Choir is by audition only. It is important to note that grade level bears no factor in determining enrollment in any ensemble at GHS. Skill level and work ethic are the determining factors in the audition process.

## **Chorale**

**Credit: 1**

**Level: 9, 10, 11, 12**

**Prerequisite: None**

Chorale is a non-auditioned, open mixed, and the entry level choral ensemble. This ensemble is ideal for students who are just entering high school and/or who have limited prior choral ensemble experience. Students will learn about basic choral singing through performance. The course includes topics such as vocal pedagogy techniques, sight reading, basic music theory, and a wide array of cultural and historical perspectives through repertoire selection. Reflection, analysis, and excellence are the pillars of the course. Participation in WSMA Solo and Ensemble Festivals is optional, but highly encouraged. Placement in Chorale is by default should a student choose not to audition for concert choir.

## **Music Theory**

**Credit: .5**

**Level: 10, 11, 12**

The Music Theory course is designed to enhance music skills and basic music fundamentals and is open to any GHS student. Music is purposefully and intentionally constructed, and this course will educate the music student as to why music works in the ways it currently does. The essential aspects of melody, harmony, rhythm, and form are studied. Throughout the course of the semester students will study basic notation, scales, key signatures, intervals, triads, cadences, non-chord tones, transposition, form, part-writing, 4-part chorale style writing, counterpoint in various species, and analysis of a score. Aural dictation, sight singing, and ear training are also an integral part of the course and will be taught in conjunction with the content listed prior. Individual creativity is nurtured through both rhythmic and melodic composition. This course is highly recommended for students in a musical ensemble, for those thinking of pursuing any type of post-secondary music education, and

is a prerequisite for AP Music Theory. The concepts listed above are essential for success in AP Music Theory, and will most definitely be a determining factor in deciding whether a not a student should undertake AP Music Theory.

## **AP Music Theory**

**Credit: .5**

**Level: 10, 11, 12**

**Prerequisite: Music Theory**

**Fees: \$98 for the AP Exam (optional)**

Students must also be enrolled in band or choir. In this class we will study advanced topics of music theory and notation. Activities will include written and aural examples of concepts. Content includes composition, harmonic progression, seventh chords, and modulation. Students will complete the semester by writing their own music composition. This course is for any advanced music student but is strongly recommended for students who seek to complete a collegiate major or minor in music. Students will learn to apply musical knowledge to become better at identifying and using the correct written and aural application of music within the western context. The class also prepares students to take the Advanced Placement test in May. Receiving a passing grade on the test can earn a student up to 10 college credits.

## **Music Appreciation**

**Credit: .5**

**Level: 9, 10, 11, 12**

**Note: No prior music experience necessary**

Music Appreciation is open to all students at GHS.. In Music Appreciation students will learn what it is about music that makes us enjoy it. Students will also learn about many genres of music, and discuss the histories of each genre and how composers and artists make us feel things when we listen to music.

## **Fundamentals of Theater**

**Credit: .5**

**Level: 11, 12**

**Prerequisite: None**

This course is designed for students who have an interest in theater, the application of theatrical theory, or the technical aspects of production and/or production design. It will provide an introduction to reading and writing scripts, directing, acting, and theater technology. Exposure to all elements of a production, from initial stages of selecting a show to creating programs and programming lighting or audio devices, will be covered. Students enrolled in the course will be given hands-on experiences with concurrent running of the school's annual musical, including lights, sound, hair, makeup, set design, stage management, technical direction, and personnel management. Students will develop a well-rounded theatrical experience that will instill an appreciation for theater arts and prepare them for a future in this area.



# PHYSICAL EDUCATION AND HEALTH

## 9th Grade

- Health
- Phy Ed 9

## 10th Grade

- Net Games
- Officiating
- Outdoor Adventure
- Personal Fitness
- Strength Training
- Advanced Strength Training
- Team Sports
- PE Leadership

## 11th Grade

- Net Games
- Officiating
- Outdoor Adventure
- Personal Fitness
- Strength Training
- Advanced Strength Training
- Team Sports
- PE Leadership

## 12th Grade

- Net Games
- Officiating
- Outdoor Adventure
- Personal Fitness
- Phy Ed 12
- Strength Training
- Advanced Strength Training
- Team Sports
- PE Leadership

### High School Requirements:

1.5 credits of Physical Education and .5 Credits Health

*Students will participate in a variety of health-enhancing physical activities to promote a healthy and active lifestyle. They will demonstrate responsible personal and social behavior by exhibiting self control, cooperative skills, appropriate sports related behavior, and regard for safety.*

## **Advanced Strength Training**

**Credit: .5**

**Level: 10, 11, 12**

**Prerequisite: Strength Training or teacher approval**

**Fees: \$10**

***Course can be repeated***

This course is designed for students who wish to continue their expertise in strength training. Students who have taken Strength Training (or receive instructor approval) and wish to excel in this area would benefit from this course. The course will focus on building strength training and agility knowledge. This course is designed for students who have experience in the development of strength, speed, agility and flexibility. The focus of this class is to use body weight, free weights, and Olympics lifts to develop overall strength, core stabilization, flexibility, and injury prevention.

## **Health**

**Credit: .5**

**Level: 9**

This course is designed to have individuals successfully develop, establish, and achieve positive lifestyle goals. To develop health promotion and prevention of health problems. The topics discussed in this class include but are not limited to: Health Promotion, Substance use and Abuse, Nutrition and Eating Disorders, Mental Health and Wellness, as well as Human Growth and Development.

## **Net Games**

**Credit: .5**

**Level: 10, 11, 12**

**Fees: \$10**

The emphasis of this class will focus on lifetime and recreation activities and the continued development of overall fitness. The activities in this class may include, but are not limited to: golf, tennis, badminton, pickleball, table tennis, archery, aquatics and personal fitness. Each unit will give instruction on skill, strategy and relevant fitness concepts.

## **Personal Fitness**

**Credit: .5**

**Level: 10, 11, 12**

**Fees: \$10**

***Course can be repeated***

This course investigates personal fitness and wellness. Students will engage in a variety of activities that improve cardiovascular endurance, muscular strength, muscular endurance and flexibility. An emphasis is placed on students developing a basic understanding of a variety of exercise techniques. Activities in class include, but are not limited to: yoga, kettlebell workouts, fitness activities, weight training, Zumba, Pilates, step aerobics and water aerobics.

## **Strength Training**

**Credit: .5**

**Level: 10, 11, 12**

**Fees: \$10**

***Course can be repeated***

Students will learn about human movement science while also participating in a wide variety of weight training, strength training and conditioning activities. Students will explore human muscle anatomy, various exercise tests, performance training and other alternative methods of training. The students will be in the fitness center and gymnasium training an average of four days per week, with one day of cross training.

## **Physical Education 9**

**Credit: .5**

**Level: 9**

This course is designed to develop fundamental skills in individual and team activities. An emphasis is placed on student understanding of the reason for and value of physical activities as well as current techniques. The activities in this class may include, but are not limited to: lacrosse, soccer, ultimate frisbee, volleyball, basketball, biking, tennis in-line skating, aquatics, CPR/AED training and fitness activities.

## **Physical Education 12**

**Credit: .5**

**Level: 12**

**Fees: \$10**

Students will participate in a variety of team, individual and net sports. The emphasis in this class will focus on recreational activities. Activities in class include, but are not limited to: tennis, table tennis, badminton, basketball, floor hockey, curling, bowling, aquatic team games, volleyball, triball, softball and golf.

## **Phy Ed Leaders**

**Credit: .5**

**Level: 10, 11, 12**

**Prerequisite: PE9 With Teacher Approval/Application Completion**

Students in P.E. Leadership are trained to assist with the instruction and supervision of students in Adapted P.E. Peer leaders are exposed to the education of students who have varying abilities. Peer leaders will follow the department policies on dressing, attendance, and assessment. Emphasis is placed on individual participation and leadership. Units include both team and individual sports, skills for Special Olympic competitions, weight training, aerobics, and fitness testing. This course is limited to approximately 5 students per semester based on need.

## **Officiating**

**Credit: .5**

**Level: 11, 12 (grade 10 with teacher approval)**

This course will focus on teaching students how to officiate different sports. Throughout this course students will become a registered (WIAA) official in a sport of their choice along with learning how to officiate a variety of other sports. For each sport we learn how to officiate, the students will be learning the rules to the game, proper positioning while the game is going on, how to handle situations with players, coaches, and parents, as well as other situations an official might encounter. The class will require active participation in simulated games in order to allow students to gain experience being an official. The sports that the course will focus on are, but not limited to: soccer, baseball, softball, basketball, football, and volleyball.

## **Outdoor Adventure**

**Credit: .5**

**Level: 10, 11, 12**

**Prerequisite: PE 9 and Health**

**Fees: \$25**

Students who have a passion for the outdoors will experience hiking, rock climbing, camping, fishing, orienteering, archery, biking, curling, kayaking, and much more. Winter lessons will include cross country skiing, snowshoeing and winter camping skills.

## **Team Sports**

**Credit: .5**

**Level: 10, 11, 12**

**Fees: \$10**

This class will focus on lifetime and recreational activities and the continued development of overall fitness. The activities in this class may include, but are not limited to: softball, cooperative games, floor hockey, ultimate frisbee, basketball, lacrosse, bowling, curling, speedball, team handball, volleyball, flag football, soccer, aquatics and badminton.





# SCIENCE

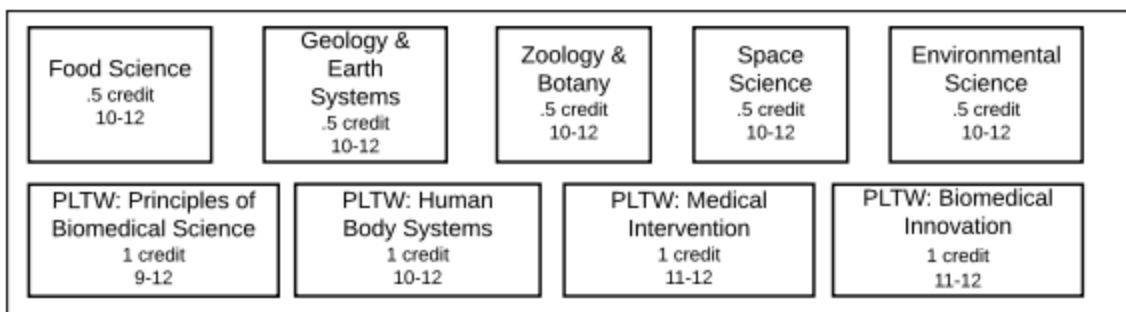
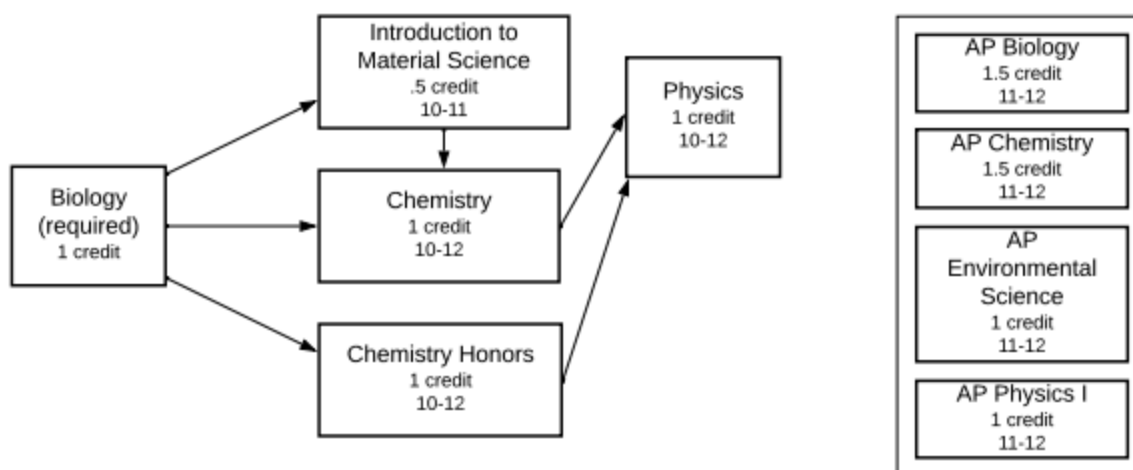

**OR**

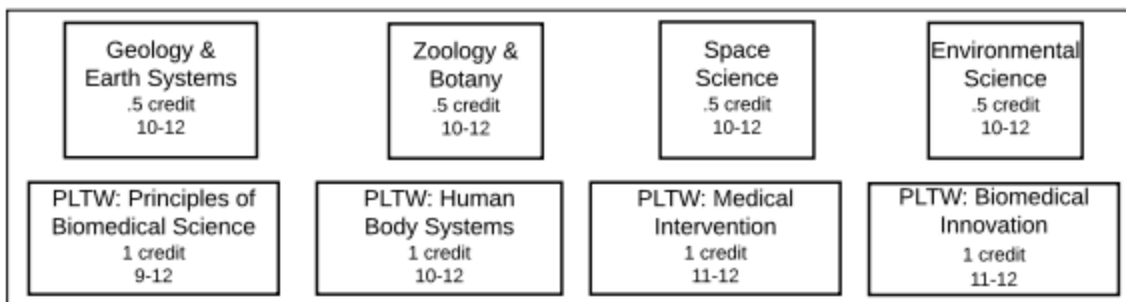
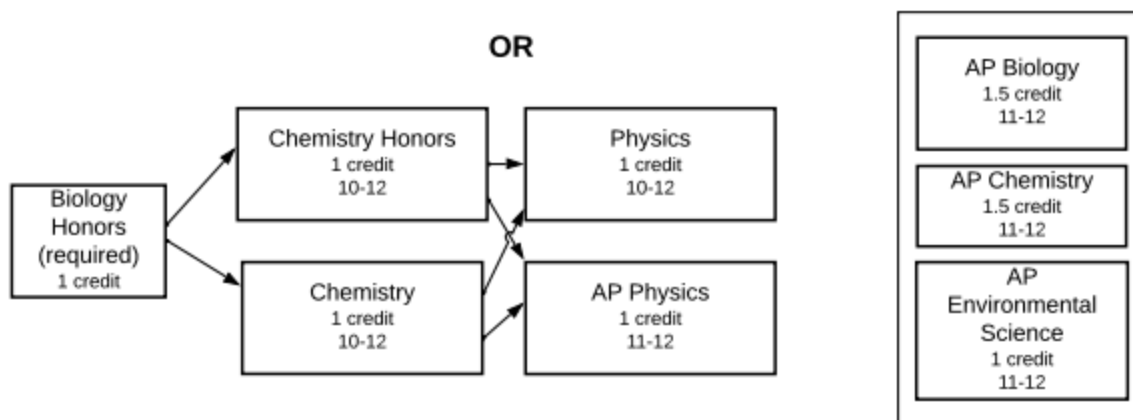

## **AP Biology**

**Credit: 1.5**

**Level: 11, 12**

**Prerequisite: Biology and Chemistry; recommendation by the Science Department staff**

**Fee: \$96 for the AP Exam (optional)**

AP Biology is a rigorous, year-long weighted course designed to be taught on a first-year college level. Upon completion of the course the student will be prepared to take the AP Biology Exam which, if passed, may give the student up to 10 hours college credit in Life Science. Student's independent study of each unit is critical to their success as class time is devoted to discussion and lab activity. Units of study include:

- The process of evolution drives the diversity and unity of life
- Biological systems utilize energy and molecular building blocks to grow, reproduce, and maintain homeostasis
- Living systems retrieve, transmit, and respond to information essential to life processes
- Biological systems interact and these interactions possess complex properties

## **AP Chemistry**

**Credit: 1.5**

**Level: 11, 12**

**Prerequisite: Chemistry; Physics recommended. recommendation by the Science Department staff**

**Fees: \$20. \$98 for the AP Exam (optional)**

AP Chemistry is a rigorous, year-long weighted course designed to be taught on a first-year college level. Upon completion of the course the student will be prepared to take the AP Chemistry Exam which, if passed, may give the student up to 10 hours college credit in Chemistry. Student's independent study of each unit is critical to their success as class time is devoted to discussion and lab activity. Units of study include Stoichiometry, Thermochemistry, Electron Structure of Atoms, Chemical Equilibrium, Gases, Solubility Equilibria, Oxidation/Reduction, Electrochemistry, and Acids and Bases.

## **AP Environmental Science**

**Credit: 1**

**Level: 11, 12**

**Prerequisite: Chemistry (or concurrent enrollment) and recommendation by the Science Department staff**

**Fees: \$96 for the AP Exam (optional)**

AP Environmental Science is a rigorous, year-long weighted course designed to be taught on a first-year college level. Upon completion of the course the student will be prepared to take the AP Environmental Science Exam which, if passed, may give the student up to 3 hours college credit in Environmental Studies. Student's independent study of each unit is critical to their success as class time is devoted to discussion and lab activity. Units of study include Earth Systems, Biogeochemical Cycles, Soil Science, Agriculture, Ecology, Population Studies, Land Use, Energy Resources and Consumption, Global Climate Change, and Pollution.

## **AP Physics 1**

**Credit: 1**

**Level: 11, 12**

**Prerequisite: Chemistry and AP Precalculus (or concurrent enrollment with AP Precalculus).**

**Fees: \$98 for the AP Exam (optional)**

AP Physics I is a rigorous, year-long weighted course designed to be taught on a first year college level. Upon completion of the course, the successful student should be able to take and pass the AP Physics I Exam which, if passed, may give the student up to 5 college credits depending on the university. The course is divided into Newtonian mechanics. Extensive use of math is required. Students must be in a minimum of Pre-Calculus to enroll and concurrent enrollment in a calculus course is recommended. Additionally, there will be a field trip to the Kalahari or other suitable entity for the study of motion.

## **Biology**

**Credit: 1**

**Level: 9**

**Note: Biology is a required course for graduation**

Biology is the study of ecology, cell biology/microbiology, biochemistry, enzymes and metabolism, molecular biology and techniques, heredity, and evolution. Students will learn to apply the concepts central to biology, while gathering and interpreting data during laboratory experiments.

## **Biology Honors**

**Credit: 1**

**Level: 9**

**Prerequisite: Teacher Recommendation**

Biology Honors integrates the same topics as Biology but at an increased pace with greater depth and focus on science process (data gathering and analysis, experimental design). Students will also have increased exposure to inquiry based lab activities.

## **Chemistry**

**Credit: 1**

**Level: 10, 11, 12**

**Prerequisite: It is recommended that students who earn a C+ or lower in Algebra wait one year to take Chemistry.**

**Fees: \$20**

Chemistry is a lab intensive course where students will problem-solve, think critically, analyze and collaborate while studying the structure of matter and the changes it undergoes.

Topics investigated include atomic and molecular structure, chemical reactions, stoichiometry, and periodic table. Students will demonstrate their understanding of concepts through several lab practicals throughout the course. Students that do not meet the prerequisites listed above should wait a year to take Chemistry and enroll as a Junior to have better success.

## **Chemistry Honors**

**Credit: 1**

**Level: 10, 11, 12**

**Prerequisite:** It is recommended that students had successful completion of Geometry and Biology with a B or better and have successfully completed Algebra 2 or are concurrently enrolled.

**Fees: \$20**

Accelerated Chemistry integrates the same topics as Chemistry but at an increased pace with a greater depth and focus on mathematical applications, data analysis, and predictions. Chemistry Honors is highly recommended for students interested in taking AP Science courses and upper level PLTW courses.

## **Environmental Science**

**Credit: .5**

**Level: 10, 11, 12**

**Prerequisite:** It is recommended that students are either concurrently enrolled or have completed Chemistry.

Topics explored include: current environmental events, waste disposal, air quality, water quality, soil pollution, and endangered species. You will also help in the Testing the Waters activities at the Milwaukee River. Introductory concepts involving environmental science that go beyond biology, showing the interrelation between the student and the environment will also be included.

## **Geology and Earth Systems**

**Credit: .5**

**Level: 10, 11, 12**

**Prerequisite: None**

Geology and Earth Systems is designed to interpret and understand the world around you. In order to do so, students will investigate and study the interactions between the four major Earth's spheres, including the geosphere, atmosphere, hydrosphere and biosphere in order to explain Earth's formation, processes, history, landscapes, how and why Earth changes over time. Topics to be addressed include, but are not limited to, the scientific method, mapping Earth's surface, minerals, rocks, plate tectonics, earthquakes, volcanoes, and geologic time. Students will participate in laboratory exercises, small group activities, web based investigations, class discussions, projects, and research.

## **Introduction to Material Science**

**Credit: .5**

**Level: 10, 11**

**Prerequisite:** Biology. This course should be taken before Chemistry, as it helps prepare students for further physical science courses.

**Fees: \$15**

Material Science is a lab-intensive course that will focus on the fundamental relationship between the structure, properties, processing and performance of materials. Students will study the metal, polymer, ceramics/glass and composite material families. Material Science will help prepare students for Chemistry, therefore it may only be taken prior to Chemistry, not concurrently.

## **Physics**

**Credit: 1**

**Level: 10, 11, 12**

**Prerequisite:** Algebra 2 and Chemistry (or concurrent enrollment in both)

In Physics, students will design experiments, analyze data, create graphs, and synthesize information into conclusions. These skills will be applied to motion, projectiles, forces, energy, collisions, electricity, sound and optics. Students will have the opportunity to collect data in a "real-life" situation at the Kalahari (waterpark and amusement park) field trip. The Physics class is designed to prepare students for college-level science as well as the ACT.

Students have shown to be more successful in Physics if they have completed Chemistry first, and are enrolled in a math class of Algebra 2 or higher.

## **PLTW: Principles of Biomedical Science**

**Credit: 1**

**Level: 9, 10, 11, 12**

**Prerequisite:** Biology (or concurrent enrollment)

**Fees: \$25**

Students explore concepts of biology and medicine as they take on roles in different medical professions to solve real-world problems. Over the course of the year, students are challenged in various scenarios including investigating a crime scene to solve a mystery, diagnosing and proposing treatment to patients in a family medical practice, to tracking down and containing a medical outbreak at a local hospital, stabilizing a patient during an emergency, and collaborating with others to design solutions to local and global medical problems. This course is designed for 9<sup>th</sup> or 10<sup>th</sup> grade students. *This course is eligible for a college transcript with a grade, transcribed credits without a grade, scholarships, or advanced standing at local and national post-secondary institutions.* Visit <https://www.pltw.org/experience-pltw/student-opportunities> for more information.

## **PLTW: Human Body Systems**

**Note:** Anatomy and Physiology course

**Credit: 1**

**Level: 10, 11, 12**

**Prerequisite:** Biology, Chemistry or concurrent enrollment in Chemistry. **PLTW: Principles of Biomedical Science is encouraged but not required.** Students enrolled in AP science courses who are interested in this course can enter directly into PLTW: HBS.

**Fees: \$25**

Students examine the interactions of body systems as they explore identity, power, movement, protection, and homeostasis. Students design experiments, investigate the structures and functions of the human body, and use data acquisition software to monitor body functions such as muscle movement, reflex and voluntary action, and respiration. *This course is eligible for a college transcript with a grade, transcribed credits without a grade, scholarships, or advanced standing at local and national post-secondary institutions.* Visit <https://www.pltw.org/experience-pltw/student-opportunities> for more information.

### **PLTW: Medical Intervention**

**Credit: 1**

**Level: 10, 11, 12**

**Prerequisite: Biology, Chemistry or concurrent enrollment in Chemistry. Recommended completion of Principles of Biomedical Science and/or Human Body Systems.**

**Fees: \$25**

Medical Intervention guides students through the life of a fictitious family as they investigate how to prevent, diagnose and treat disease. Students explore how to detect and fight infection; screen and evaluate the code in human DNA; conquer cancer; and prevail when the organs of the body begin to fail. Through real-world cases, students are exposed to a range of interventions related to immunology, surgery, genetics, pharmacology, medical devices, and diagnostics. *This course is eligible for a college transcript with a grade, transcribed credits without a grade, scholarships, or advanced standing at local and national post-secondary institutions. Visit <https://www.pltw.org/experience-pltw/student-opportunities> for more information.*

### **PLTW: Biomedical Innovation**

**Credit: 1**

**Level: 11, 12**

**Prerequisite: Biology, Chemistry and 2 additional PLTW courses. Highly motivated individuals who excel at project-based learning. AP Biology and/or AP Chemistry are encouraged but not required.**

**Fees: \$25**

This is the final course in the PLTW Biomedical Science sequence. Students will build on the knowledge and skills gained from previous courses to design innovative solutions for the most pressing health challenges of the 21<sup>st</sup> century. Students address topics ranging from public health and biomedical engineering to clinical medicine and physiology. *This course is eligible for a college transcript with a grade, transcribed credits without a grade, scholarships, or advanced standing at local and national post-secondary institutions. Visit <https://www.pltw.org/experience-pltw/student-opportunities> for more information.*

### **Space Sciences**

**Credit: .5**

**Level: 10, 11, 12**

**Prerequisite: Algebra**

Space Sciences includes the study of the Earth-moon-sun system, the solar system, the galaxy and the universe. Students will learn how processes in space work, how scientists study space and how space technology affects our life on Earth. Students will be able to explain how phenomena such as phases of the moon, seasons and auroras are caused. Students will participate in hands-on labs, which will at times involve the use of basic math, including ratios and other basic skills from algebra and pre-algebra. Students will learn about theoretical astronomical concepts like black holes and string theory. Students will also understand space technology, such as GPS and communications satellites, are used and how they can be affected by events in space such as solar flares.

### **Zoology/Botany**

**Credit: .5**

**Level: 10, 11, 12**

**Prerequisite: Biology**

**Fees: \$25**

Zoology/Botany will explore diversity of life, with an emphasis on zoology and botany. It involves hands-on dissection of multiple organisms for the purpose of comparative studies of anatomical systems. Additionally, students will have access to the GHS greenhouse to grow many of their own plants for laboratory purposes. Although the focus will be on the plant and animal kingdoms, fungi and protists may also be covered.

# SOCIAL STUDIES

Global Studies\*  
9  
1 credit

US History \*\*  
10  
1 credit

Ancient History  
11, 12  
.5 credit

OR

OR

AP Human  
Geography\*  
9  
1 credit

AP US  
History\*\*  
10  
1 Credit

Medieval History  
11, 12  
.5 credit

American  
Government\*\*\*  
10, 11, 12  
.5 credit

World Issues  
11, 12  
.5 credit

Geography  
10, 11, 12  
.5 credit

AP  
Macroeconomics  
11, 12  
.5 credit

Sociology  
10, 11, 12  
.5 credit

AP  
Microeconomics  
11, 12  
.5 credit

Revolutions  
10, 11, 12  
.5 credit

AP Psychology  
11, 12  
1 credit

American  
Issues  
10, 11, 12  
.5 credit

Intro to  
Education  
11,12  
.5 credit

**\*Required 9th grade:  
Global Studies  
or  
AP Human Geography**

**\*\*Required 10th grade:  
US History  
or  
AP US History**

**\*\*\*Required to graduate  
10th, 11th, or 12th grade:  
American Government**

## **American Government**

**Credit: .5**

**Level: 10, 11,12**

**Note: This is a required course for graduation**

This course focuses on the formation and purposes of governments as well as the creation, organization and powers of the Legislative and Executive Branches of the Federal Government. This course also focuses on the Federal Judiciary, as well as rights and responsibilities as a citizen. The purpose of this class is to acquaint the student with an understanding of the institutions of democracy and the organizations of the Executive, Legislative, and Judicial branches.

## **American Issues**

**Credit: .5**

**Level: 10, 11, 12**

This course will help develop an ability to rationally discuss current issues in American policy from factual and research. Reading, debate, library research, and small group discussion are emphasized in this class. Students will use current event materials and will explore important trends in modern America. Students will analyze our country today focusing on current events.

## **Ancient History**

**Credit: .5**

**Level: 11, 12**

Early Human development, Egyptian Society, Mesopotamian Society, Greek Society, and Roman Society are examined. Students will be able to develop a system of note taking that allows them to prepare for comprehensive single question essay question tests. Students will analyze various procedures for preparing and taking an essay test as a means of finding a system that will work for them in content oriented college courses. Students will be graded on not only the essay's content but on the form of the essay itself. There will be three term papers throughout the semester.

## **AP Human Geography**

**Credit: 1**

**Level: 9**

**Prerequisite: Recommendation from Middle School Social Studies Teacher and Parent Permission**

**Fees: \$98 for the AP Exam (optional);**

**\$15 fee for purchasing the AP Human Geography Ultimate Review Packet online subscription.**

This course introduces students to the systematic study of patterns and processes that have shaped human understanding, use, and alteration of Earth's surface. Students employ spatial concepts and landscape analysis to examine human social organization and its environmental consequences. Students will learn about the methods and tools geographers use in their science and practice. On successful completion of the course the students should be able to: use and think about maps and spatial data, understand and interpret the implications of associations among phenomena in places, recognize and interpret at different scales the relationships among patterns and processes, define regions and evaluate the regionalization process, characterize and analyze changing interconnections among places. Interested

students may take the Advanced Placement Human Geography examination in the spring.

## **AP Macroeconomics**

**Credit: .5**

**Level: 11, 12**

**Fees: \$15 fee for purchasing the AP Economics Ultimate Review Packet online subscription.** The subscription includes a video for each of the units in AP Economics. It also includes review note outlines, key terms, and vocabulary for each unit. The subscription also has practice tests and quizzes for each unit; **\$98 for the AP Exam (optional)**

**Note: This course fulfills the Financial Literacy graduation requirement**

The purpose of Macroeconomics is to provide students a thorough understanding of GDP, unemployment, inflation, the role of consumers, business, and government in the macro economy, international trade, taxes, the Federal Reserve, national debt, and the deficits. Students will focus on problem solving and critical thinking skills in this course. Serious economic problems such as national debt, inflation/stagflation, recession, depression, trade imbalance, taxing and savings rates, banking reform, etc. will be explored with potential solutions to the economic problems presented. Students will be tested based on their ability to logically apply various economic theories to real world problems.

## **AP Microeconomics**

**Credit: .5**

**Level: 11, 12**

**Prerequisite: AP Macroeconomics**

**Fees: \$15 fee for purchasing the AP Economics Ultimate Review Packet online subscription.** The subscription includes a video for each of the units in AP Economics. It also includes review note outlines, key terms, and vocabulary for each unit. The subscription also has practice tests and quizzes for each unit; **\$98 for the AP Exam (optional)**

**Note: This course fulfills the Financial Literacy graduation requirement**

In Microeconomics, the study of the laws of supply and demand are expanded and focused on, the role of business and markets, theory of the firm and factors of production, choices between Wages, Labor, and Capital, Externalities, Public v Private Goods, Tax Shifting. Students will focus on problem solving and critical thinking skills in this course. Various microeconomic concepts such as individual and business supply/ demand, elasticity, and markets will be explored with potential solutions to economic problems presented using marginal analysis. Public and private goods as well as taxes and their impact will also be studied. Students will be tested based on their ability to logically apply various economic theories to real world problems. Students will have the opportunity to take two AP exams, Microeconomics and Macroeconomics, in May.

## AP Psychology

**Credit: 1**

**Level: 11, 12**

**Fees: \$98 for the AP Exam (optional)**

The goal of this course is to examine the mental processes and behaviors of individuals in society today. It is a college level course that students can earn 3 college credits if they take and pass the AP Psychology exam. Topics vary from the physiological workings of the brain and nervous system-to the abstract workings of the mind. Historical study will be included focusing on the works of a variety of early Psychologists. The course will also study development, motivation, emotion, consciousness, learning, and memory. Units dealing with abnormal psychology, treatment, and social psychology will tie many of the different ideas together. The course includes an emphasis on content knowledge and application, requiring high level thinking skills and an in depth approach to the material.

## AP U.S. History

**Credit: 1**

**Level: 10**

**Prerequisite: recommendation of Freshman Social Studies teacher.**

**Fees: \$15 fee for purchasing the AP US History Ultimate Review Packet online subscription.** *The subscription includes a video for each of the units in AP US History. It also includes review note outlines, key terms, and vocabulary for each unit. The subscription also has practice tests and quizzes for each unit.* **\$98 for the AP Exam (optional)**

**Note: U.S. History or AP U.S. History is required for graduation**

The AP U.S. History course is designed to provide students with the analytical skills and factual knowledge necessary to deal critically with the problems and materials in U.S. History. The program prepares students for intermediate and advanced college courses by making demands upon them equivalent to those made by full year college introductory courses. Students should learn to assess historical materials and their relevance to a particular historic problem. AP U.S. History will help students develop the skills necessary to arrive at conclusions on the basis of an informed judgment and to present reasons and evidence clearly and persuasively in essay format.

## Geography

**Credit: .5**

**Level: 10, 11, 12**

A study of the history of the social, economic, and political structure of nations of several continents and countries of the World. Examples: Africa, U.S.A., South Asia, Australia, etc. In the process of studying these nations and their locations, the history of each culture is stressed. A special emphasis is given to the many cultures that have enriched the U.S. Students will review map-reading skills and be able to locate the major landforms and countries on a map and globe. Students will analyze through videos, films, articles, and projects the great diversity of cultures in the world today, determining those things that are similar in all cultures and those things that may differ from culture to culture.

[Table of Contents](#)

## Global Studies

**Credit: 1**

**Level: 9**

**Note: This course or AP Human Geography is required for graduation**

Global Studies focuses on the study of physical geography, culture, history, economics and current events around the globe. The course will include studying those themes across North America, Europe, Africa, Asia and Oceania.



## Introduction to Education

**Credit: .5**

**Level: 11, 12**

Pending: College credit is available through UW-Oshkosh Cooperative Academic Partnership Program (CAPP) for students who meet program requirements. More information can be found [here](#).

The intent of this course is for students to become better informed about the Pre-K to 12th grade teaching profession. Students will explore the history and culture of K-12 education through multiple lenses with emphasis on becoming aware of roles needed for schools to function successfully. Students will reflect on their own educational journey, examine teacher standards, techniques used to engage all students, interact with education stakeholders, and look critically at issues within education.

Students will have the opportunity to attend site visits and explore different schools and classroom settings, analyze what it is like to be a teacher, and lead discussion and activities in the classroom.

## Medieval History

**Credit: .5**

**Level: 11, 12**

A study of the political, social, and economic development of people and their society from the Fall of Rome up to the Renaissance. There will be three term papers throughout the semester. Students will analyze various medieval writings including biographies, essays, journals, etc.; comparing and contrasting the ideas found in those writings to modern day concepts. Students will be able to describe medieval life and thought in broad categories, supporting this with facts found in the readings. Students, ultimately, will be able to describe the Medieval World in the context of people and ideas, noting those ideas that were unique to that era and those that are common to humanity at any time.

## Revolutions

**Credit: .5**

**Level: 10, 11, 12**

This course examines why revolutions occur and their significance. The course will cover content from the Renaissance to current day. Major revolutions that will be focused on include: The Reformation, French and Russian Revolution and China and Cuba. These revolutions will be used as case studies to learn the different signs and stages of revolution and examine political and social impacts.



## **Sociology**

**Credit: .5**

**Level: 10, 11, 12**

Basic Sociology including sociological technique and research, culture, groups, personality, social class and the family. Students will analyze social problems and issues to better understand behavior. Students will learn to factually and rationally discuss the problems and issues of human behavior. Students will learn through discussions, case studies, videos, simulations, etc. explore and seek to understand other people's points of view. Students will learn to listen to controversial issues, gather data, and factually respond to issues.

## **U.S. History**

**Credit: 1**

**Level: 10**

**Note: U.S. History or AP U.S. History is required for graduation**

A study of the major historical events from approximately 1861-1933 is presented in the first semester and a study of the major historical events from 1933 to the present is presented in the second semester. In both semesters a special effort is made to correlate the influences of the political, social, and economic factors to our world today. This final required social studies class is designed to give students a broad understanding of our nation's history. It primarily deals with our history from the post Civil War/Reconstruction era to the present. This course focuses on the diversity of our history in the last century. The course will look at the various problems our country has faced and how we have solved them.

## **World Issues**

**Credit: .5**

**Level: 11, 12**

Students will learn how to use current information and historical background to make reasoned judgments about current problems and issues in the world. Students will seek through research, discussion and lecture to understand others points of view concerning contemporary world issues. Students will have a greater awareness and appreciation for the global climate in which they live and be aware of current occurrences across the globe. The course provides background on U.S. foreign policy and the people and organizations which shape it. Students will have an understanding of problems facing the world today, as well as a historical understanding of conflict in different regions of the world.



# TECHNOLOGY AND ENGINEERING

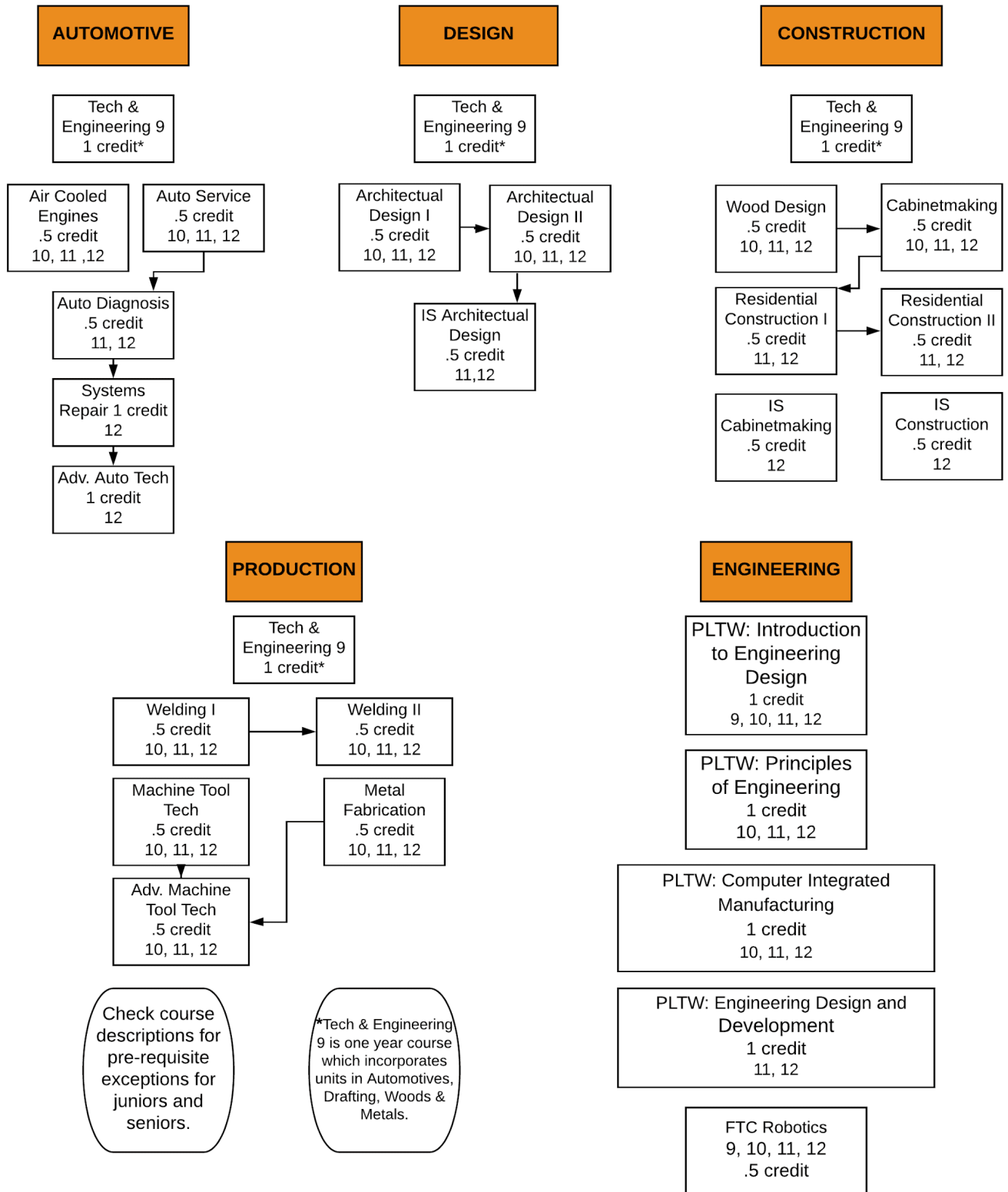

**Recommended Engineering Sequence:**  
 PLTW: IED → PLTW: POE →  
 PLTW: CIM → PLTW: ED

## Advanced Autos

**Credit:** 1 (2<sup>nd</sup> semester/every day)

**Level:** 12

**Prerequisite:** Final grades of "B-" or better in Auto Service, Auto Diagnosis, and Auto Systems Repair. Instructor approval needed.

**Fees:** \$10 lab materials

**FVTC transcribed course for 12 credits**

This course explores automotive engine overhaul, manual transmission and clutches, automatic transmission, air conditioning theory. It is expected that all information and skills from *prerequisite courses* be able to be applied during Advanced Auto Tech labs. The class offers at least one hour every day of lab time since more intense projects such as engine and transmission overhauls will be attempted. Students enrolled in this class will be required to perform high quality vehicle service in a time frame that is competitive with industry flat rate. Students in automotive competitions are required to be enrolled in this class. Content is based on ASE Standards and *accomplishing ASE tasks A1, A2, A3 & A7 is a major emphasis*. Career Pathways in transportation, distribution, and logistics will be emphasized. Students will finalize their understanding of total vehicle repair and service. This course will prepare the student for entry level positions in the field of automotive repair. It will also give them an edge in technical college courses involving automobile service and repair. *Students with career goals in mechanical engineering will also benefit from the course*. During the semester, students will take the ASE Student Certification Exam that is in each ASE Area A1-A8 and AST.

### ***Fox Valley Technical College Credit Opportunity***

*FVTC and Grafton High School have partnered to offer students the option of earning FVTC credit while still in high school. In alignment with our ASE recertification and Fox Valley Technical College partnership students are required to complete all courses in the automotive sequence and earn a B- or higher in each course. Also, students enrolled in Advanced Autos will be expected to attend BHT on Thursdays and Fridays throughout the school year.*

## Advanced Machine Tool Technology

**Credit:** .5

**Level:** 10, 11, 12

**Prerequisite:** Machine Tool Tech or Metal Fabrication

**Fees:** \$35 project fee

This is an advanced level course designed to give students a deeper understanding of computer aided machining processes (CNC). Students will use a variety of software to design and program parts machined on a variety of CNC machines. Advanced Machine Tool Technology is recommended for all students, especially those looking to pursue a career in engineering or take part in a youth apprenticeship.

## Air-Cooled Engine Technology

**Credit:** .5

**Level:** 10, 11, 12

**Fees:** \$10 lab materials plus any personal engine parts needed

**Note:** This course is not a prerequisite for other automotive courses.

Students will perform disassembly, measuring, testing, diagnosis, repair, and reassembly of power equipment and air-cooled engines. Tests on current production engines will be emphasized. The student will learn the operational characteristics of both 2 stroke-cycle and 4 stroke-cycle engines. A special emphasis on electrical engine systems and transaxles will be included in the subject matter. Students will also be introduced to the concepts considered in engineering an internal combustion engine. Students may service their own engines and will work on shop engines that are in the 2 through 20 horsepower range.

## Architectural Design 1

**Credit:** .5

**Level:** 10, 11, 12

**Fees:** \$5 lab fee

To further acquaint students with residential architectural designs, including the designing and drawing of a residential home and a brief study of building codes, and structural symbols. Career Pathways in designing, planning, managing, building and maintaining the built environment will be emphasized.

## Architectural Design 2

**Credit:** .5

**Level:** 10, 11, 12

**Prerequisite:** Architectural Design 1

**Fees:** \$5 lab fee

To permit students interested in architectural drawing to further their studies in more complicated structural problems. To design electrical, plumbing and heating systems, cost analysis, modular components, specifications, and building loads. Career Pathways in designing, planning, managing, building and maintaining the built environment will be emphasized.

## Auto Diagnosis

**Credit:** .5

**Level:** 11, 12

**Prerequisite:** Instructor approval needed.

**Fees:** \$10 lab materials

This is an *advanced level course* that is strictly "driveability-oriented". There is a heavy emphasis on electrical and electronic theory. The student will learn diagnostic procedures involving the use of professional test equipment such as oscilloscopes, digital volt-amp-ohm meters, infrared exhaust analyzers, computer scan tools, precision measuring tools, and a variety of pressure, vacuum, leakage, temperature and sound testing devices. There is as much theory as there is hands-on emphasis in this course. It is designed for the student seriously considering a career in some type of repair, engineering, or testing of automobiles and their

systems. Content is based on ASE Standards and *accomplishing ASE tasks A6 & A8 is a major emphasis*. Career Pathways in transportation, distribution, and logistics will be emphasized. This class is taken in preparation for Systems Repair and Advanced Auto Tech.



### **Auto Service**

**Credit:** .5

**Level:** 10, 11, 12

**Prerequisite:** Instructor approval needed.

**Fees:** \$10 lab materials

**FVTC transcribed course for 4 credits**

This is an entry-level course in the study of the automobile and its systems. It will meet the needs of the students who just want to know more about the motor vehicles they will be driving, as well as the first course in the full progression of the automotive technology program. This course requires no previous mechanical experience. Students will learn through a combination of regular class work (written assignments, lectures, discussions, and tests) and hands-on lab activities, based on ASE Standards. By using professional service and testing equipment, the student will become safe and lightly skilled at routine service and maintenance of automobiles. Career Pathways in transportation, distribution, and logistics will be emphasized. *Auto body work is not covered in class.*



### **Auto Systems Repair**

**Credit:** 1 (1<sup>st</sup> semester/every day)

**Level:** 12

**Prerequisite:** Final grades of "B-" or better in Air-Cooled Engine Technology, Auto Service and Auto Diagnosis. Instructor approval needed.

**Fees:** \$10 lab materials

Auto Systems Repair lightly covers all previously learned diagnosis and testing of vehicle systems. In addition, the new emphasis is on steering, suspension, brake and chassis systems. Students will learn repair and service procedures on anti-lock brake systems, will perform front wheel alignments, tire mounting and balancing and replacement of major steering and suspension components. This is truly a class that is concerned with performing major vehicle repairs. Content is based on ASE Standards and *accomplishing ASE tasks A4 & A5 is a major emphasis*. Career Pathways in transportation, distribution, and logistics will be emphasized. Since this is a first semester-senior year class, selection for automotive competitions is made from the students enrolled in this class by taking the ASE MLR test. A high ability level and an interest in an automotive career is a usual characteristic of a student taking this *advanced level course*. This class is taken in preparation for Advanced Auto Tech.

### **Cabinetmaking**

**Credit:** .5

**Level:** 10, 11, 12

**Prerequisite:** Wood Design

**Fees:** \$35 for materials; additional fees may be charged depending on projects

The student will develop an understanding of the more advanced wood machine procedures and safety of the machines. The student will become acquainted with the occupational requirements related to the cabinetmaking field. The student will work on one self-designed project. Career Pathways in designing, planning, managing, building and maintaining the built environment will be emphasized.

### **FTC: Robotics**

**Credit:** .5

**Level:** 9-12

**Fees:** \$25 for competition costs

**Prerequisite:** A background in programming, electronics or engineering design. Completion of Introduction of Programming and/or Principles of Engineering and/or a prior member of FIRST Lego League or Instructor Approval.

Students in First Tech Robotics will design, build and program a robot to perform a specific task specified by the First Organization. Additionally, students will be asked to connect with community organizations to raise funds for their team. There will be additional time required outside of school hours as we approach competition dates. Competition dates will typically be on a Saturday or Sunday in the months of December, January and/or February. This is a course students can take every year and can earn up to a total of 2 credits. Students unable to fit this course into their schedule can still participate as a member of FTC outside of the school day

### **Machine Tool Technology**

**Credit:** .5

**Level:** 10, 11, 12

**Fees:** \$35 project fee

This is an entry-level course designed to give students a basic understanding of computer aided machining processes (CNC). Students will use a variety of software to design and program parts machined on a CNC mill. Machine Tool Technology is recommended for all students, especially those looking to pursue a career in engineering or take part in a youth apprenticeship.

### **Metal Fabrication**

**Credit:** .5

**Level:** 10, 11, 12

**Fees:** \$35 project fee

This is an entry-level course designed to give students an understanding of basic machining and metalworking processes. Students will develop machining skills and knowledge necessary for manufacturing and engineering careers. Class projects may include: tic-tac-toe game, shovel, dice, and a handcart. Metal Forming is recommended for all students, especially those looking to pursue a career in engineering or take part in a youth apprenticeship.

## PLTW: Computer Integrated Manufacturing



**Credit: 1**

**Level: 10, 11, 12**

**Fees: \$35 lab materials**

This course illuminates the opportunities related to understanding manufacturing. At the same time, it teaches students about manufacturing processes, product design, robotics, and automation. Students will explore how CNC machines and robots are utilized to produce a manufactured product. This course will provide students interested in an engineering pathway the opportunity to explore possible engineering careers.

## PLTW: Engineering Design & Development



**Credit: 1**

**Level: 11, 12**

**Fees: \$20 lab materials**

**Note: Must take at least two of the following courses in order to enroll in PLTW Engineering Design & Development.**

The knowledge and skills students acquire throughout PLTW Engineering come together in Engineering Design and Development as they identify an issue and then research, design and test a solution, ultimately presenting their solution to a panel of engineers. Students apply the professional skills they developed to document a design process to standards, completing Engineering Design and Development ready to take on any post-secondary program or career.

## PLTW: Introduction to Engineering Design



**Credit: 1**

**Level: 9, 10, 11, 12**

**Fee: \$20 lab materials**

This is the first PLTW course in the Engineering career pathway. Students dig deep into the engineering design process, applying math, science, and engineering standards to hands-on projects. They work both individually and in teams to design solutions to a variety of problems using 3-D modeling software, and use an engineering notebook to document their work. This course will provide students interested in an engineering pathway the opportunity to explore possible engineering careers.

## PLTW: Principles of Engineering



**Credit: 1**

**Level: 10, 11, 12**

**Fee: \$20 lab Materials**

Principles of Engineering is a team-based advanced course providing opportunities for students to explore

[Table of Contents](#)

engineering content related to energy, Power, materials, Control systems, robotics and Statistics. Students will apply engineering related math and science while completing activities and projects. This course will provide students interested in an engineering pathway the opportunity to explore possible engineering careers.

## Residential Construction 1

**Credit: .5**

**Level: 11, 12**

**Prerequisite: Wood Design or senior standing**

**Fees: \$30 lab materials**

The student will work on a "mock-up" of a single story ranch house. The student will be able to estimate the cost for building a house. The student will experiment with all phases of rough construction including: foundations, framing of floors, walls, doors/windows, ceilings, and roofs. The student will develop the ability to read and interpret blueprints. Career Pathways in designing, planning, managing, building and maintaining the built environment will be emphasized.

## Residential Construction 2



**Credit: .5**

**Level: 11, 12**

**Prerequisite: Residential Construction 1**

The student will work on a "mock-up" of a single story ranch house. The student will experiment with all phases of finish construction work including: basic electrical wiring, basic plumbing, interior finished wall coverings, window/door installations, advanced roof framing, roof coverings, and siding. Career Pathways in designing, planning, managing, building and maintaining the built environment will be emphasized.

## Technology & Engineering 9

**Credit: 1 (four 9-week segments)**

**Level: 9**

**Fees: \$35 lab materials**

**Note: This course is a prerequisite for Air-Cooled Engine Technology if planning on taking all the automotive classes in order to earn post-secondary credits and ASE certifications. However, if a student is only exploring the automotive options and does not plan on taking Systems Repair and Advanced Autos this class is not a prerequisite.**

This course is a study of the technologies used in business and industry. Every nine weeks the students will experience a different area of technology. They will study metals and manufacturing, power and transportation, woodworking, and computer-aided drafting and design. They will learn by operating hand tools, machinery, equipment, and software in each area

## **Welding 1**

**Credit: .5**

**Level: 10, 11, 12**

**Fees: \$35 lab materials. Student must furnish approved welding gloves**

Students will explore the following weld processes with main emphasis on GMAW:

SMAW (ARC Welding), Oxy-Fuel – Cutting, GMAW (Mig Welding), GTAW (Tig Welding), and CNC plasma Cutting. Course content will explore Career Pathways related to manufacturing, and develop the entry level skills needed to pursue a Youth Apprenticeship at a local manufacturing company. This course is designed to teach students the fundamentals of welding in a wide range of positions. All students will work towards completion of entry level welding standards. Students will build a race car chassis for a Formula High School Racecar.

## **Welding 2**

**Credit: .5**

**Level: 10, 11, 12**

**Prerequisite: Welding 1**

**Fees: \$35 lab materials. Student must furnish approved welding gloves**

---

## **Independent Seminar-Cabinetmaking**

**Credit: .5 or 1**

**Level: 11, 12**

**Prerequisite: Wood Design, Cabinetmaking, Mechanical Design, and teacher approval**

**Fees: varies depending on project**

The student will have the opportunity to explore advanced areas of study related to the cabinetmaking field. The student and the instructor will decide, in advance, the area or areas to be studied. The student will have the opportunity to observe the operation of a cabinet shop within the community.

## **Independent Seminar-Construction**

**Credit: .5 or 1**

**Level: 12**

**Prerequisite: Residential Construction I and II, Architectural Drafting, and teacher approval**

The student will have the opportunity to explore advanced areas of study related to the construction field. The student and the instructor will decide, in advance, the area or areas to be studied. The student will have the opportunity to observe the operation of a residential construction company within the community.

## **Independent Seminar – Welding 3**

**Credit: .5 or 1**

**Level: 11, 12**

**Prerequisite: Welding 2 and teacher approval**

**Fees: Varies depending on projects**

The student will have the opportunity to explore advanced areas of study related to a career in the welding field. The student and instructor will decide the areas to be studied.

Students will explore the following weld processes with main emphasis on GMAW:

SMAW (ARC Welding), Oxy-Fuel – Cutting, GMAW (Mig Welding), GTAW (Tig Welding), and CNC plasma Cutting. The course will place an emphasis on welding in vertical positions. Major course project includes completion and operation of a Formula High School race car. All students will work towards mastery of entry level welding standards that can lead to manufacturing youth apprenticeship opportunities and competition in SkillsUSA Welding Events.

## **Wood Design**

**Credit: .5**

**Level: 10, 11, 12**

**Fees: \$35 for materials; additional fees may be charged depending on projects**

The student will develop an understanding of the basic wood machine procedures and safety of machines. The student will become acquainted with the occupational requirements related to the woodworking field. The student will work on six assigned projects. Career Pathways in designing, planning, managing, building and maintaining the built environment will be emphasized.

---

## **Independent Seminar - Machining**

**Credit: .5 or 1**

**Level: 12**

**Prerequisite: Advanced Machine Tool and teacher approval**

**Fees: Varies depending on projects**

The student will have the opportunity to explore advanced areas of study related to a career in the machining field. The student and instructor will decide in advance the area or areas to be studied, and projects to be completed.

## **Independent Seminar – Arch Design**

**Credit: .5 or 1**

**Level: 11, 12**

**Prerequisite: Architectural Design I and II, teacher approval**

**Fees: Varies depending on projects**

The student will have the opportunity to explore advanced areas of study related to the mechanical or architectural design field. The student and the instructor will decide, in advance, the area or areas to be studied. The student will work on multiple short-term projects relating to the area or areas being studied.

## **Applied Interdisciplinary Math**

**Credit: ¼ per approved Tech/Engineering course**

**Level: 10, 11, 12**

Applied Interdisciplinary Math (AIM) is a math credit embedded into select Technology and Engineering (T&E) classes. Please see your school counselor with any questions.

# WORLD LANGUAGE

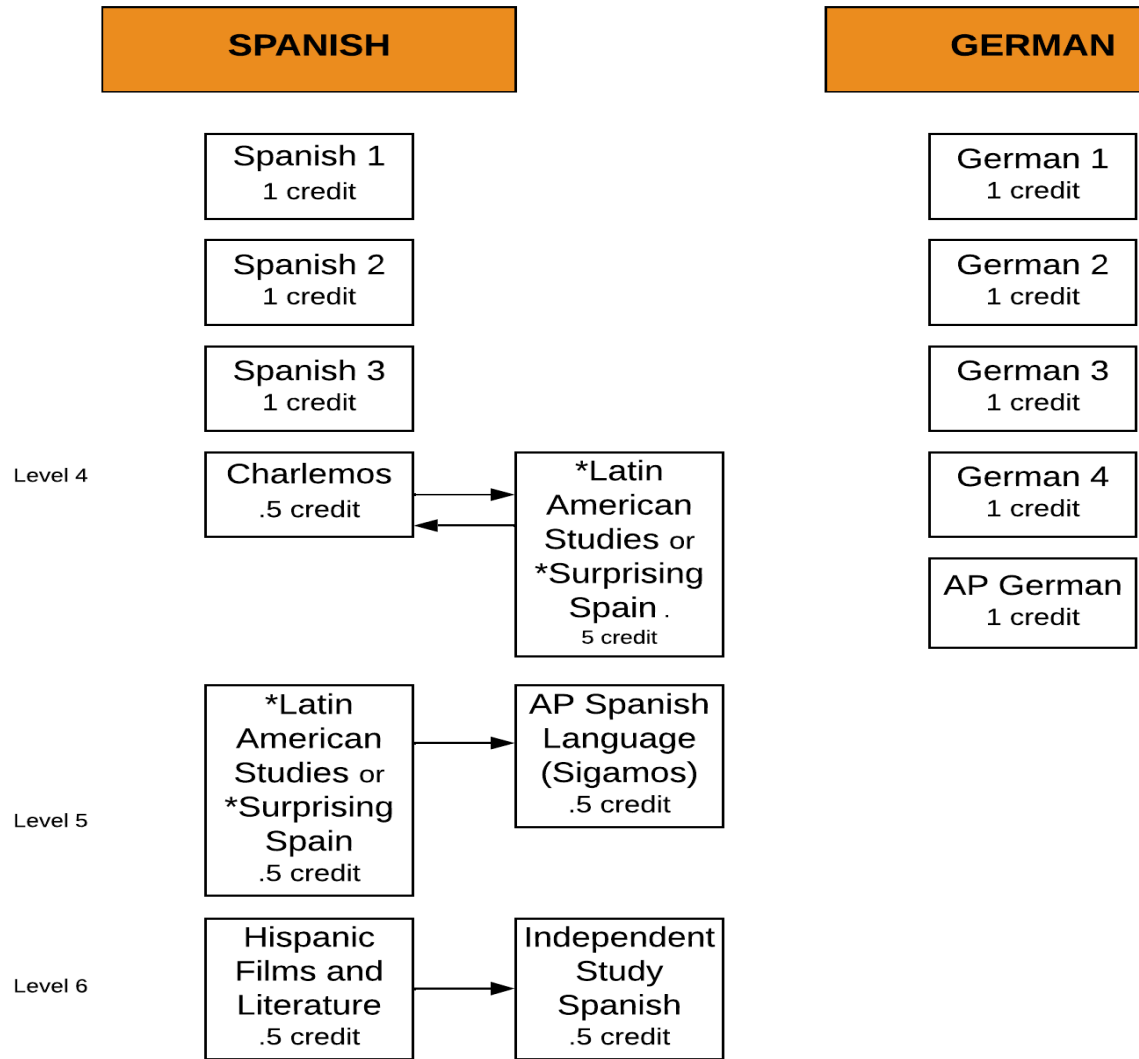

*\* Each course is offered every other year*

## **Spanish 1**

**Credit: 1**

**Level: 9, 10, 11, 12**

Spanish 1 begins the study of the language and cultures of the Spanish-speaking world. Grammar and vocabulary are practiced at the introductory level with speaking, listening, reading, and writing activities. Through readings, videos, and cultural activities students begin to learn about Hispanic contributions to culture and civilization. In this class, we will use more Spanish as the year progresses. The Autentico online textbook and ancillary materials are used in this course.

## **Spanish 2**

**Credit: 1**

**Level: 9, 10, 11, 12**

**Prerequisite: Spanish 1**

*It is recommended that students earn a "C" or better in Spanish I in order to take Spanish II.*

Spanish 2 continues the study of the language and cultures of the Spanish-speaking world. Grammar, vocabulary, speaking, listening, reading, and writing skills are the focus of this course. Through readings, videos, and cultural activities, the students continue to learn about Hispanic contributions to culture and civilization. This class will be taught in Spanish with some English. The Autentico online textbook and ancillary materials are used in this course.

## **Spanish 3**

**Credit: 1**

**Level: 10, 11, 12**

**Prerequisite: Spanish 2**

*It is recommended that students earn a "C" or better in Spanish II in order to take Spanish III.*

This course is a comprehensive approach to developing more advanced Spanish language skills including reading, writing, speaking and listening. Emphasis will be on paired and small group work. Through readings, videos, and cultural activities the students continue to learn about Hispanic contributions to culture and civilization. The class will be taught in Spanish with some English. This course concludes with the Autentico online textbook series.

## **Charlemos**

**Level 4 conversation course**

**Credit: .5**

**Level: 11, 12**

**Prerequisite: Spanish 3**

A major focus of the course is development of the ability to converse. We will review and add new grammar structures and vocabulary. This course will help the students be able to use Spanish orally whether in a foreign country or living and working in the United States.

## **Surprising Spain**

**Level 4/5 cultural course, offered every other year**

**Credit: .5**

**Level: 11, 12**

**Prerequisite: Spanish 3**

Students will study the geography, history, music, dance, food, and overall daily life and culture of Spain. This course is taught almost exclusively in Spanish. Students will continue to learn and build their vocabulary base and advanced grammar skills by reading, writing, listening, and speaking in Spanish.

*Note: Students will need to cook one authentic Spanish dish with a partner or group of three during our "Foods of Spain" unit. Cost will vary depending on the recipe chosen.*

## **Latin American Studies**

**Level 4/5 cultural course, offered every other year**

**Credit: .5**

**Level: 11, 12**

**Prerequisite: Spanish 3**

Students will study the geography, history, music, dance, food, and overall daily life and cultures of Latin American countries. This course is taught almost exclusively in Spanish. Students will continue to learn and build their vocabulary base and advanced grammar skills by reading, writing, listening, and speaking in Spanish.

*Note: Students will need to cook an authentic meal with a partner or group of three during our "Foods in Latin America" unit. Cost will vary depending on the recipe chosen.*



## **AP Spanish Language**

**Credit: .5**

**Level: 12**

**Prerequisite: Charlemos, Spanish 3 and both cultural classes**

This course will be a comprehensive review of advanced grammatical concepts focusing heavily on the subjunctive mood in the present. This course will include a variety of authentic reading/listening sources such as: short stories, poems, proverbs, music, and a movie in Spanish. All four skills of reading, writing, listening and speaking will be covered. This class is conducted almost exclusively in Spanish.

### **SPANISH COLLEGE CREDIT OPPORTUNITY:**

*The University of WI - Green Bay and Grafton High School have partnered up to offer students the option of earning UW credit while still in high school. To be eligible for this program, students must enter Spanish 2 as freshmen. The prerequisite is three years of high school Spanish. Students will need to sign up for and take both AP Spanish and the last cultural studies Spanish course in their senior year. Students will also sign up for Spanish 202 through the University of WI- Green Bay. If students earn an average of B or better, they will earn 3 University of WI credits and 11 retroactive credits. Any questions, please see your Spanish teacher and/or school counselor. UW Green Bay determines the cost of the 3 credits in August prior to school starting.*

## **Hispanic Films and Literature**

**Credit:** .5

**Level:** 12

**Prerequisite:** Latin American Studies, Surprising Spain, AP Spanish Language

This course introduces students to a variety of short stories and movies from Spain and Latin America. It will provide students with ongoing and varied opportunities to further develop their proficiency across a range of language skills—with special attention to reading and writing—and to encourage students to reflect on the many voices and cultures included in a rich and diverse body of authentic literature written in Spanish and authentic film produced in Spain/Latin America. We will compare and contrast a few different film genres (surrealism, melodrama, Hollywood realism, etc.) in their Hispanic contexts. Students will study the work of renowned Latino, Spanish, and Latin American authors. Students will analyze important cultural and historical events in the films and literature (the Guatemalan Civil War, Hispanic superstitions, the Spanish/Moor conflicts, Columbian drug trafficking, etc.)

## **German 1**

**Credit:** 1

**Level:** 9, 10, 11, 12

German 1 is an introduction to the language and culture of the German-speaking countries. Students are actively engaged as they learn to speak, listen, read, and write German at a basic level. Topics of study include: the classroom, time and numbers, weather and calendar, food and family, free time activities, food and clothing. Culture, geography and grammar are integrated into each unit. The Mosaik textbook and supplements are supplied to each student.

## **German 2**

**Credit:** 1

**Level:** 9, 10, 11, 12

**Prerequisite:** German 1

German 2 is a continuation of German 1, making progress toward a novice high level of proficiency in both written and spoken German. Topics at this level include personal descriptions, health, city vs. country living, travel and student life which increase the use and understanding of German vocabulary and grammar, and help students identify opportunities to learn and use German outside the classroom. The Mosaik textbook and supplements are supplied to each student.

## **German 3**

**Credit:** 1

**Level:** 10, 11, 12

**Prerequisite:** German 2

German 3 expands students' listening, speaking, reading and writing skills in more creative situations, making progress toward an intermediate low to mid level of proficiency in German. Students identify opportunities to learn and use German outside the classroom, and to recognize its potential for personal growth, enrichment, and enjoyment. This class is mostly taught in German. The Mosaik textbook and supplements are supplied to each student.

## **German 4**

**Credit:** 1

**Level:** 11, 12

**Prerequisite:** German 3

Students will be immersed in the German language and culture through a variety of assignments and activities based on National Foreign Language Standards. Students work toward an intermediate mid-level of proficiency or higher, and prepare for college placement exams. German 4 students are introduced to many authentic materials: books, films, news, and websites. Students use the Internet and German websites weekly. German 4 topics include: current events, European history and geography, the environment, music and poetry, celebrations, studying and working abroad, and a short novel. This course is conducted almost entirely in German.



## **AP German Language & Culture**

**Credit:** 1

**Level:** 12

**Prerequisite:** German 4

AP German Language and Culture is a rigorous college course designed for highly motivated students to improve their German proficiency and knowledge. Instruction is in German, with an emphasis on refining and expanding speaking, reading and writing, working toward an advanced low to mid level of proficiency. Authentic texts, films and materials are provided. Themes include: International Business, the Environment, Science and Technology, Music and Poetry, and Comparisons of Family and Society. Students will obtain skills to help qualify for professional work in various areas such as business, teaching, translating and interpreting, and become prepared to attend German courses as a college freshman.

### **GERMAN COLLEGE CREDIT OPPORTUNITY:**

*The University of Wisconsin Green Bay and Grafton High School have partnered up to offer students the option of earning UW college credit while in high school. Students sign up for German 5 their senior year and German 202 through UW Green Bay. If students earn an average of B or better, they will earn 3 credits for the UW Green Bay German 202 course and 11 retroactive credits. UW Green Bay determines the tuition in August.*

### **GERMAN TRIP OPPORTUNITY:**

*A student trip to our partner school in Germany is offered every other year. All German students in good standing may participate.*